



APPENDIX F

FUNCTIONAL REQUIREMENTS SPECIFICATIONS

	FUNCTIONAL REQUIREMENTS SPECIFICATION	Document Code: A-0102-AFRS-P002
		Revision: 0
Client: City of Winnipeg	Project: Primary Clarifiers Travelling Bridges Refurbishment	Package / Area: PLC-P311

Prepared By: DUSTIN WILSON		2018-08-28
Name	Signature	Date
Checked By: JASON BOUCHARD		2018-08-28
Name	Signature	Date
Approved By: DUSTIN WILSON		2018-08-28
Name	Signature	Date

<p>Certificate of Authorization</p> <div style="border: 1px solid black; padding: 10px; text-align: center;">  <p>ENGINEERS GEOSCIENTISTS MANITOBA</p> <p>Certificate of Authorization</p> <p>KGS Group</p> <p>No. 245</p> </div>	<p>Professional Seal</p> <div style="text-align: center;">  </div>
--	---

REVISION REGISTER					
Rev.	Description	Date	By	Checked	Approved
0	Issued for Use	2018-08-28	D. Wilson	J. Bouchard	D. Wilson



	FUNCTIONAL REQUIREMENTS SPECIFICATION	Document Code: A-0102-AFRS-P002
		Revision: 0
Client: City of Winnipeg	Project: Primary Clarifiers Travelling Bridges Refurbishment	Package / Area: PLC-P311

Table of Contents

1	Overview.....	3
1.1	Associated Documents	3
2	General Requirements.....	5
2.1	Human Machine Interface.....	5
2.1.1	Screen Layout.....	5
2.1.2	Graphic Displays.....	5
2.2	Inputs from Other PLCs	6
2.3	Logic and variables for other PLCs.....	6
3	Implementation	7
3.1	Simple Class Instances.....	7
3.1.1	DiscreteIA (Discrete Indication and / or Alarming).....	7
3.2	P4 – Travelling Bridges.....	8
3.2.1	Clarifier 1 Travelling Bridge Collector	8

	FUNCTIONAL REQUIREMENTS SPECIFICATION	Document Code: A-0102-AFRS-P002
		Revision: 0
Client: City of Winnipeg	Project: Primary Clarifiers Travelling Bridges Refurbishment	Package / Area: PLC-P311

1 OVERVIEW

The logic specified in this document is intended to provide functional requirements for PLC-P301 for the Primary Clarifier 1 Travelling Bridge. Refer to document A-0102-AFRS-A001 for general requirements and standard equipment classes. It is written from a technical perspective, and is intended to be read along with the associated Process & Instrument Diagram (P&ID) drawings.

This Functional Requirement Specification (FRS) document is intended to provide an initial basis for development of the PLC and HMI application functionality for the specific process area described herein. The Contractor must provide further development of the PLC and HMI functionality described in this document for a complete and functional system. It is written from a technical perspective and is intended to be read in parallel with the Process Control Narratives (PCNs), the associated Process and Instrument Diagrams (P&IDs), the Instrument Loop Drawings (ILDs) and the other PLC related contract documents. In the event of any discrepancy or any ambiguity, the PCNs, P&IDs, ILDs and other contract documents take precedence (in no specific order of importance) over the FRS documents. Any significant discrepancy should be clarified with the Contract Administrator. All discrepancy resolutions should be documented and submitted as part of the as-built markups. If there are discrepancies from a scope of work perspective, the more stringent requirement shall apply. All scope of work discrepancies should be clarified with the Contract Administrator.

Control functions are described using pseudo code and encapsulated in classes (some of which are commonly applicable for similar or identical equipment systems). These classes may therefore be instantiated as necessary to control similar types of equipment throughout the facility. Each class defines a control interface whose inputs and outputs are interconnected to implement the overall process control strategy as defined by the PCNs, P&IDs, ILDs, etc. and the FRS document. The specific area FRS documents are supported by the General FRS document which provides common definitions for software development required throughout the entire facility.

While the FRS documents provide specific guidance with respect to software development, they should not be presumed to be comprehensive of all software development requirements. Ultimately the P&IDs, the PCNs and the ILDs will govern and take precedence. It is the responsibility of the Contractor to utilize its expertise to provide a fully functional set of developed software in accordance with the contract documents even if not described within the FRS document at no additional cost to the contract. It is the specific responsibility of the Contractor to identify, seek clarification and ultimately resolve any issues of ambiguity, interpretation, uncertainties or discrepancies between the FRS documents and the associated contract documents. This responsibility extends to the need for consultation, as necessary, with the process designers, process equipment vendors, the Engineer, the Owner and any other relevant stakeholders to resolve any issue in accordance with the Contractor's legal obligations for the delivery of the work.

1.1 Associated Documents

The documents and drawings associated with this functional requirements specification are listed below. Additional P&ID drawings may be referenced in this document.

Document / Drawing Number	Description
1-0102-AFRS-A001	FUNCTIONAL REQUIREMENTS SPECIFICATION
612620-0014-40ER-0001	TAG NAMING STANDARD
612620-0015-40ER-0001	HMI LAYOUT AND AUTOMATION PLAN
1-0102-PPID-P401	PROCESS AND INSTRUMENTATION DIAGRAM – CLARIFIER 1 TRAVELLING BRIDGE COLLECTOR

	FUNCTIONAL REQUIREMENTS SPECIFICATION	Document Code: A-0102-AFRS-P002
		Revision: 0
Client: City of Winnipeg	Project: Primary Clarifiers Travelling Bridges Refurbishment	Package / Area: PLC-P311

Document / Drawing Number	Description
1-0102-AILD-P304 SHT. 001	LOOP DIAGRAM – RIO-P301 INPUTS / RIO-P800-2 OUTPUTS
1-0102-AILD-P304 SHT. 002	LOOP DIAGRAM – RIO-P301 INPUTS / RIO-P800-2 OUTPUTS
1-0102-AILD-P305 SHT. 001	LOOP DIAGRAM – RIO-P301 OUTPUTS / RIO-P800-2 INPUTS
1-0102-AILD-P305 SHT. 002	LOOP DIAGRAM – RIO-P301 OUTPUTS / RIO-P800-2 INPUTS
1-0102-ACBD-P301 SHT. 001	CABINET LAYOUT - PRIMARY CLARIFIERS - LCP-P301, TRAVELLING BRIDGE PLC CABINET - PLC-P301-1
1-0102-ACBD-P302 SHT. 001	POWER DISTRIBUTION SCHEMATIC - PRIMARY CLARIFIERS - LCP-P301-1, TRAVELLING BRIDGE PLC CABINET - PLC-301
1-0102-ACBD-P302 SHT. 002	POWER DISTRIBUTION SCHEMATIC - PRIMARY CLARIFIERS - LCP-P301-1, TRAVELLING BRIDGE PLC CABINET - PLC-301 - SHEET 002
1-0102-ACBD-P303 SHT. 001	WIRING DIAGRAM - PRIMARY CLARIFIERS - LCP-P301, LCP-P301-1, PLC-P301 - DISCRETE INPUTS
1-0102-ACBD-P304 SHT. 001	WIRING DIAGRAM - PRIMARY CLARIFIERS - LCP-P301, LCP-P301-1, PLC-P301 - DISCRETE OUTPUTS
1-0102-ACBD-P313 SHT. 001	CABINET LAYOUT - PRIMARY CLARIFIERS - LCP-P301-2, TRAVELLING BRIDGE PLC CABINET - RIO-P301
1-0102-ACBD-P314 SHT. 001	POWER DISTRIBUTION SCHEMATIC - PRIMARY CLARIFIERS - LCP-P301-2, TRAVELLING BRIDGE PLC CABINET - RIO-P301
1-0102-ACBD-P314 SHT. 002	POWER DISTRIBUTION SCHEMATIC - PRIMARY CLARIFIERS - LCP-P301-2, TRAVELLING BRIDGE PLC CABINET - RIO-301 - SHEET 002
1-0102-ACBD-P315 SHT. 001	WIRING DIAGRAM - PRIMARY CLARIFIERS - LCP-P301-2, RIO-P301 - DISCRETE INPUTS
1-0102-ACBD-P316 SHT. 001	WIRING DIAGRAM - PRIMARY CLARIFIERS - LCP-P301-1, PLC-P301 - DISCRETE OUTPUTS
1-0102-EGAD-P003 SHT. 001	POWER AND INSTRUMENTATION - MAIN FLOOR PLAN - PRIMARY CLARIFIER 1 & 2 ELEV 234.39M
1-0102-EMCL-P301 SHT. 001	MOTOR STARTER SCHEMATIC - TBC-P301 - PRIMARY CLARIFIER 1 TRAVELLING BRIDGE COLLECTOR
1-0102-EMCL-P301 SHT. 002	MOTOR STARTER SCHEMATIC - TBC-P301 - PRIMARY CLARIFIER 1 TRAVELLING BRIDGE COLLECTOR - SHEET 002
1-0102-EMCL-P303 SHT. 001	MOTOR STARTER SCHEMATIC - CM-P303 - PRIMARY CLARIFIER 1 COLLECTOR MECHANISM
1-0102-EMCL-P303 SHT. 002	MOTOR STARTER SCHEMATIC - CM-P303 - PRIMARY CLARIFIER 1 COLLECTOR MECHANISM
1-0102-ANET-P003 SHT. 003	NETWORK DIAGRAM - PRIMARY CLARIFIERS - DEVICE NETWORK
1-0102-ANET-P003 SHT. 004	NETWORK DIAGRAM - PRIMARY CLARIFIERS - DEVICE NETWORK

	FUNCTIONAL REQUIREMENTS SPECIFICATION	Document Code: A-0102-AFRS-P002
		Revision: 0
Client: City of Winnipeg	Project: Primary Clarifiers Travelling Bridges Refurbishment	Package / Area: PLC-P311

2 GENERAL REQUIREMENTS

Refer to document A-0102-AFRS-A001 for general requirements and standard classes.

2.1 Human Machine Interface

2.1.1 Screen Layout

The typical screen layout for the HMI graphic terminal shall be as shown in Figure 1. Navigation buttons shall reside across the bottom, a single-line alarm banner across the top, and the remainder of the screen allocated for the graphic display area. The graphic display area will be utilized for mimic displays, configuration screens, trends, and an alarm summary.

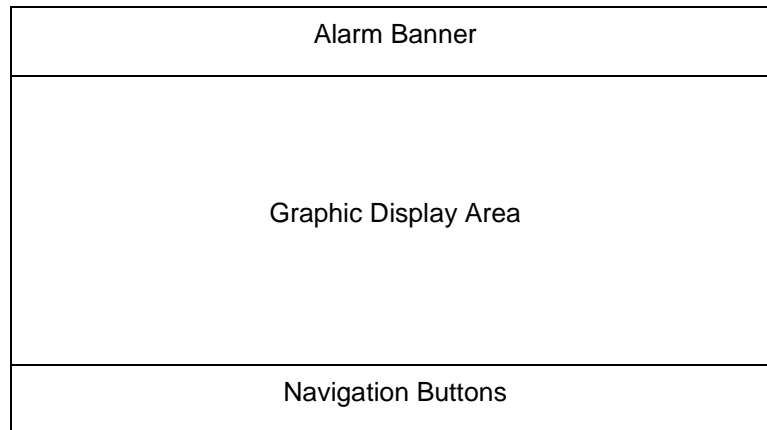

Figure 1: Screen Layout

2.1.2 Graphic Displays

Create Area Overview, Process Graphic and Detail displays as per City of Winnipeg HMI Layout and Animation plan document (612620-0015-40ER-0001) and General Functional Requirements Specification A-0102-AFRS-A001.

The following tables provide guidance on the minimum anticipated groupings of process displays, however, these should not be considered as fully defined, and modifications and additions may be required.

Note that only major or representative equipment and devices are explicitly shown in the graphic display tables. Include other devices as required for a complete HMI.

Refer to General Functional Requirements Specification A-0102-AFRS-A001 for Level 1 graphics.

Table 2.1-1 Level 2 Area P Graphic Displays – Primary Clarifier Overview

Group	Content
<ul style="list-style-type: none"> • Primary Clarifier 	TBC-P301 Clarifier 1 Travelling Bridge Collector Status <ul style="list-style-type: none"> - Bridge Sequence Status - Travelling Bridge Drive TBC-P301 Status - Sludge / Scum Scraper Hoist CM-P303 Status

	FUNCTIONAL REQUIREMENTS SPECIFICATION	Document Code: A-0102-AFRS-P002
		Revision: 0
Client: City of Winnipeg	Project: Primary Clarifiers Travelling Bridges Refurbishment	Package / Area: PLC-P311

Table 2.1-2 L3 and L4 Graphic Displays

Display Group	Level	Content
PCS Status	4	PLC Status and Basic Diagnostics for <ul style="list-style-type: none"> • Main Controller Rack • Remote I/O Rack • Networking Components (Including switch diagnostic when available) • Power Supplies
Overview Trends	4	(See Trends section below)

2.2 Inputs from Other PLCs

Some variables will be shared among different areas of the plant. They will be communicated via the Fibre Ethernet redundant ring connecting the PLCs. Variables that are read from other PLCs are listed below, along with their default value in the event of a communication failure.

The following table provides guidance on the minimum anticipated variables that are read from other PLC along with their default value in the event of a communication failure, however, these should not be considered as fully defined and modifications and additions may be required.

Input	Description	Source PLC	Value On Communication Error
T.B.D.	T.B.D.	T.B.D.	T.B.D.

2.3 Logic and variables for other PLCs

The following sections provide guidance on the minimum anticipated variables and logic required from this PLC for other PLCs, however, these should not be considered as fully defined and modifications and additions may be required.

Variable	Description	Source
PLC-P301_DiscreteInputTable	Pre-defined table for all discrete inputs	PLC-P301
PLC-P301_DiscreteOutputTable	Pre-defined table for all discrete outputs	PLC-P301
PLC-P301_AnalogInputTable	Pre-defined table for all analog inputs	PLC-P301
PLC-P301_AnalogOutputTable	Pre-defined table for all analog outputs	PLC-P301
PLC-P301_DiscreteStatusTable	Table to store discrete status information to be monitored remotely	PLC-P301
PLC-P301_IntegerTable	Table to store integer information to be monitored remotely	PLC-P301
PLC-P301_FloatingPointTable	Table to store floating point information to be monitored remotely	PLC-P301

Note: All Pre-defined tables shall include share space for the addition of two additional I/O modules.

	FUNCTIONAL REQUIREMENTS SPECIFICATION	Document Code: A-0102-AFRS-P002
		Revision: 0
Client: City of Winnipeg	Project: Primary Clarifiers Travelling Bridges Refurbishment	Package / Area: PLC-P311

3 IMPLEMENTATION

3.1 Simple Class Instances

The following tables show simple class instance implementations, other instances are shown in the rest of the document. In general, equipment with identical functionality for different systems is not explicitly shown.

3.1.1 DiscretelA (Discrete Indication and / or Alarming)

Table 3.1-1 Simple DiscretelA Instances

Instance	Source	Description	Alarms (Priority)	Notes
ZL-P3011	ZS-P3011	Clarifier 1 Bridge Drive TBC-P301 at East Position	Err(2)	P&ID: PPID-P401
ZL-P3012	ZS-P3012	Clarifier 1 Bridge Drive TBC-P301 at West Position	Err(2)	P&ID: PPID-P401
ZL-P3013	ZS-P3013	Clarifier 1 Bridge Drive TBC-P301 at East Overtravel Position	Err(2)	P&ID: PPID-P401
ZL-P3014	ZS-P3014	Clarifier 1 Bridge Drive TBC-P301 at West Overtravel Position	Err(2)	P&ID: PPID-P401
ZLL-P3031	CM-P303-ZSL	Clarifier 1 Scraper Hoist CM-P303 Lowered	Err(2)	P&ID: PPID-P401
ZLH-P3032	CM-P303-ZSH	Clarifier 1 Scraper Hoist CM-P303 Raised	Err(2)	P&ID: PPID-P401

	FUNCTIONAL REQUIREMENTS SPECIFICATION	Document Code: A-0102-AFRS-P002
		Revision: 0
Client: City of Winnipeg	Project: Primary Clarifiers Travelling Bridges Refurbishment	Package / Area: PLC-P311

3.2 P4 – Travelling Bridges

3.2.1 Clarifier 1 Travelling Bridge Collector

P&ID Drawing: PPID-P401

3.2.1.1 Clarifier 1 Travelling Bridge Control

The bridge travels East and West across the clarifier. As it travels East, the hoist will be lowered to scrape sludge to the sludge auger, and as it travels West, the hoist will be raised to push scum into the scum trough.

When the bridge reaches the West end of the clarifier (home position), it will wait for WaitTime minutes before moving East across the clarifier. Similarly, at the East end, the bridge will wait for DwellTime minutes before moving West across the clarifier. However, from the East end, the clarifier may either make a long trip (returning all the way to the West end), or a short trip, where it travels West for ShortTripCycleTime, then pauses for ShortTripPauseTime, before returning to the East end of the clarifier. This process repeats ShortTripCount times, after which the bridge travels all the way back to the West end of the clarifier.

Inputs From the HMI

Setting	Description	Initial Value	Range
HoistRaiseLowerDly	Time to allow hoist to completely raise or lower	20 sec	0 - 100 sec
DwellTime	Bridge Dwell Time (East End)	5 min	0 - 30 min
ShortTripCycles	Number of short trip from east end of clarifier	6 cycles	0 – 100 cycles
ShortTripCycleTime	Length of each short trip	10 min	0 - 60 min
ShortTripPauseTime	Pause length at the end of each short trip	6 min	0 - 60 min
WaitTime	Bridge Wait Time (West End)	6 min	0 - 30 min
SeqResume	Resume Sequence from Paused State		

Note: Perform range checking on all HMI settings inputs to ensure that they are valid.
Prefix all alarm identifiers with "YC-P3010_"

Outputs for Display on HMI

Output	Description
SeqRdy	All bridge components are in remote auto mode

	FUNCTIONAL REQUIREMENTS SPECIFICATION	Document Code: A-0102-AFRS-P002
		Revision: 0
Client: City of Winnipeg	Project: Primary Clarifiers Travelling Bridges Refurbishment	Package / Area: PLC-P311

SeqRunning	Bridge trip cycle is currently running
SeqPaused	Bridge trip cycle is currently paused
ShortTripCount	Number of short trips that have occurred in the current cycle
ShortTripTimeDisp	Amount of time elapsed in current short trip (ShortTripCycle_Timer)
ShortTripPauseDisp	Amount of time elapsed in current short trip pause (ShortTripPause_Timer)
TimeAtEast	Time elapsed in current Dwell time at East end of Clarifier (Dwell_Timer)
TimeAtWest	Time elapsed in current Wait time at West end of Clarifier (Wait_Timer)

Note: Prefix all identifiers with "YC-P3010_"

Table 3.2-1 YC-P3010_ ShortTripMode / Bridge West Direction Trip Length Selector

Instance	YC-P3010_ ShortTripMode		
Class	OnOffSel		
Inputs	Parameter	Source	Type
	SelOffText	"Long Trips"	Const
	SelOnText	"Short Trips"	Const

Table 3.2-2 YC-P3010 Clarifier 1 Travelling Bridge Control Station

Instance	YC-P3010		
Class	DiscreteCS		
Inputs	Parameter	Source	Type
	CtrlRem	N/A	Link
	CtrlLoc	N/A	Link
	Flt	YC-P3010_SeqFail.Out	Link
	RdyIn	NOT YC-P3010_SeqStopCond	Link
	Run	YC-P3010_SeqRunning	Link
	RunAuto	YC-P3010_SeqRdy OR YC-P3010.Running	Link
	StartInh	YC-P3010_SeqStopCond	Link
Alarms	(2)		

Note: Alarm priority as per default class definition or as shown

Sequence Ready Logic

YC-P3010_SeqRdy := YC-P3010_BridgeDrive.Rdy AND YC-P3030_BridgeHoist.Rdy AND NOT(CM-P303.Maint)

	FUNCTIONAL REQUIREMENTS SPECIFICATION	Document Code: A-0102-AFRS-P002
		Revision: 0
Client: City of Winnipeg	Project: Primary Clarifiers Travelling Bridges Refurbishment	Package / Area: PLC-P311

Sequence Stop Conditions

Set YC-P3010_SeqStopCond and stop the travelling bridge sequence (by immediately going to State 5 in the sequence) if ANY of the following stop conditions are true:

- NOT YC-P3010_SeqRdy (Sequence not ready)
- YC- P3010_SeqFail.In (Sequence fault condition)
- NOT YC-P3010.CmdRun AND YC-P3010.Running

Sequence Fault Conditions

Set YC-P3010_SeqFail if ANY of the following conditions are true:

- Any step in the sequence is active for longer than Tmax seconds, where Tmax is the maximum time allowed for a given step (See Sequence for Sludge Transfer below)

Set YC-P3010_EastMoveFault if ANY of the following conditions are true:

- Loss of Hoist Lowered Limit Switch (ZL-P3031.Out) for Tdelay seconds, where Tdelay is a time delay of 1-5 seconds.

Set YC-P3010_WestMoveFault if ANY of the following conditions are true:

- Loss of Hoist Raised Limit Switch (ZL-P3032.Out) for Tdelay seconds, where Tdelay is a time delay of 1-5 seconds.

	FUNCTIONAL REQUIREMENTS SPECIFICATION	Document Code: A-0102-AFRS-P002
		Revision: 0
Client: City of Winnipeg	Project: Primary Clarifiers Travelling Bridges Refurbishment	Package / Area: PLC-P311

3.2.1.2 YC-P3010_Sequence / Clarifier 1 Travelling Bridge Sequence

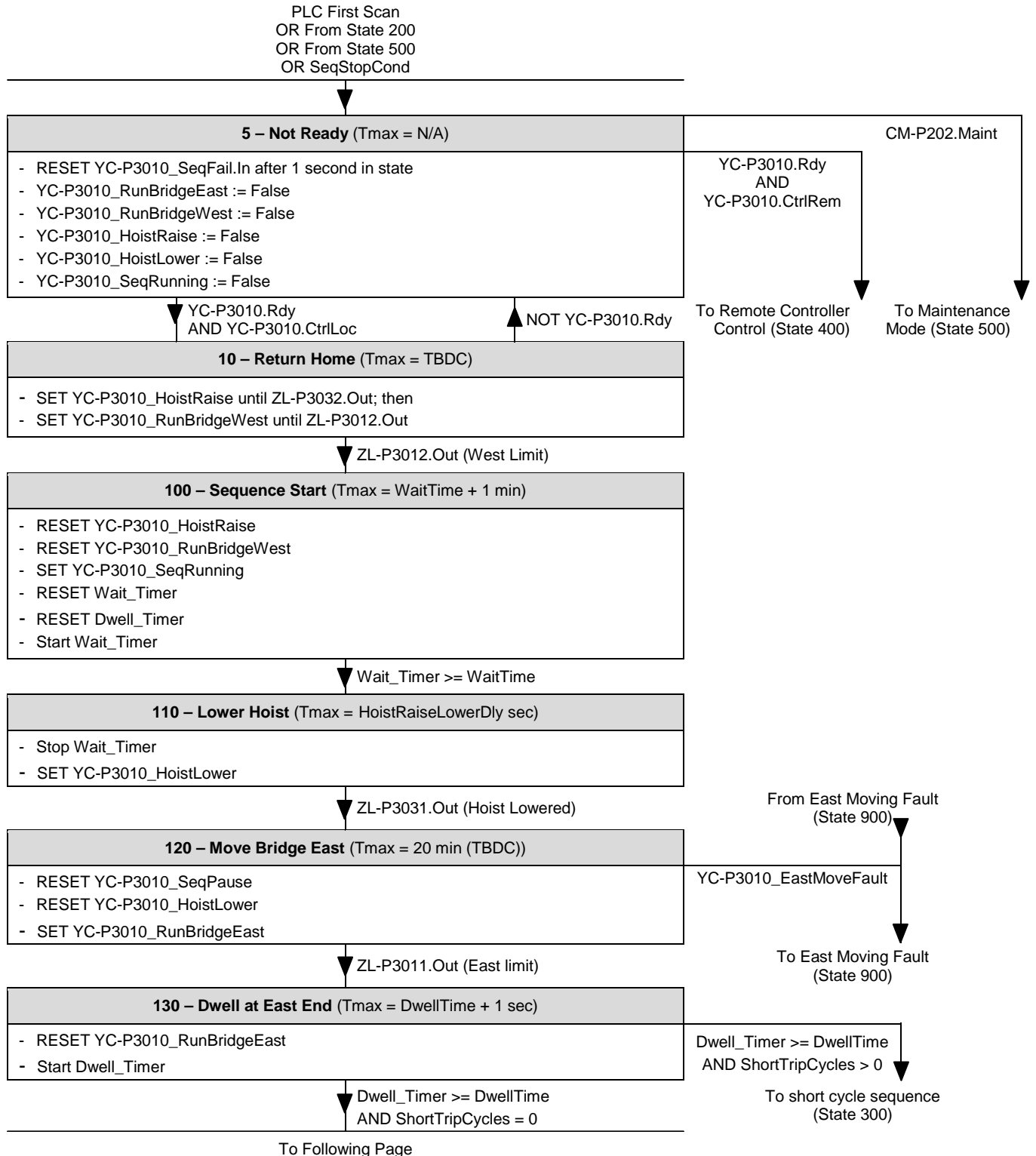

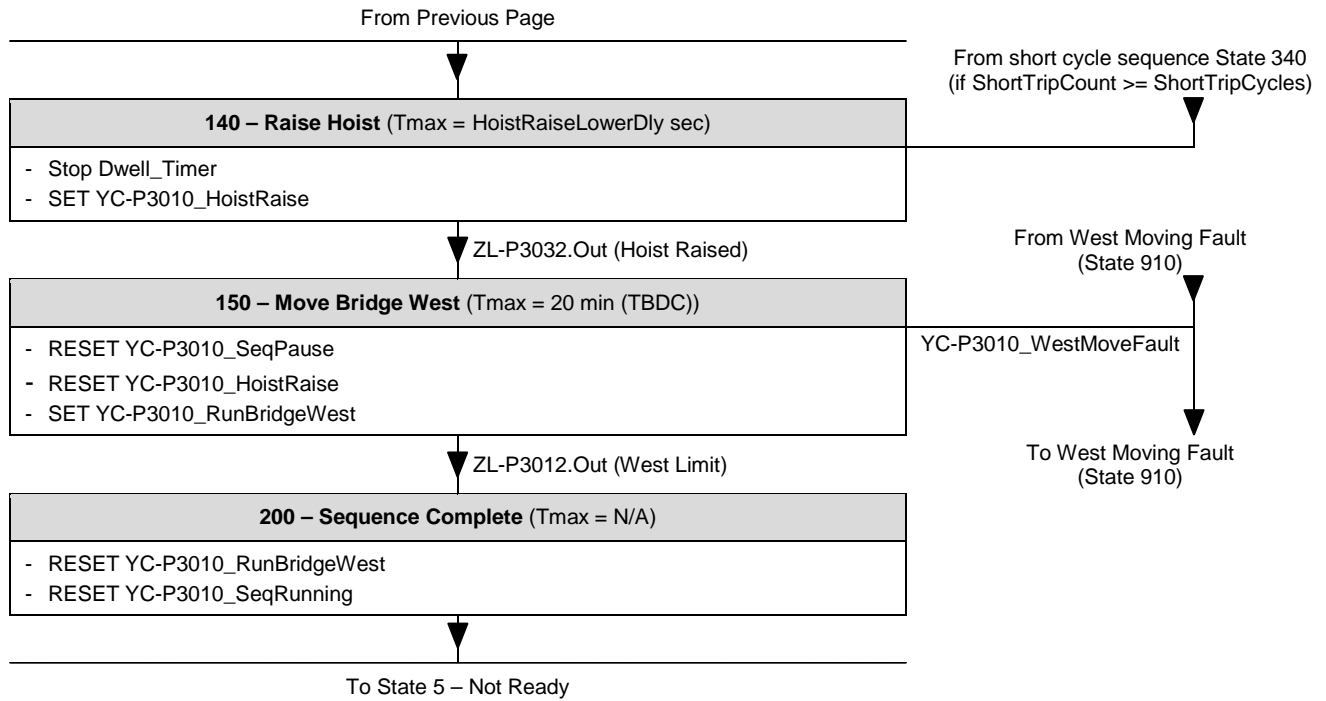

	FUNCTIONAL REQUIREMENTS SPECIFICATION	Document Code: A-0102-AFRS-P002
		Revision: 0
Client: City of Winnipeg	Project: Primary Clarifiers Travelling Bridges Refurbishment	Package / Area: PLC-P311

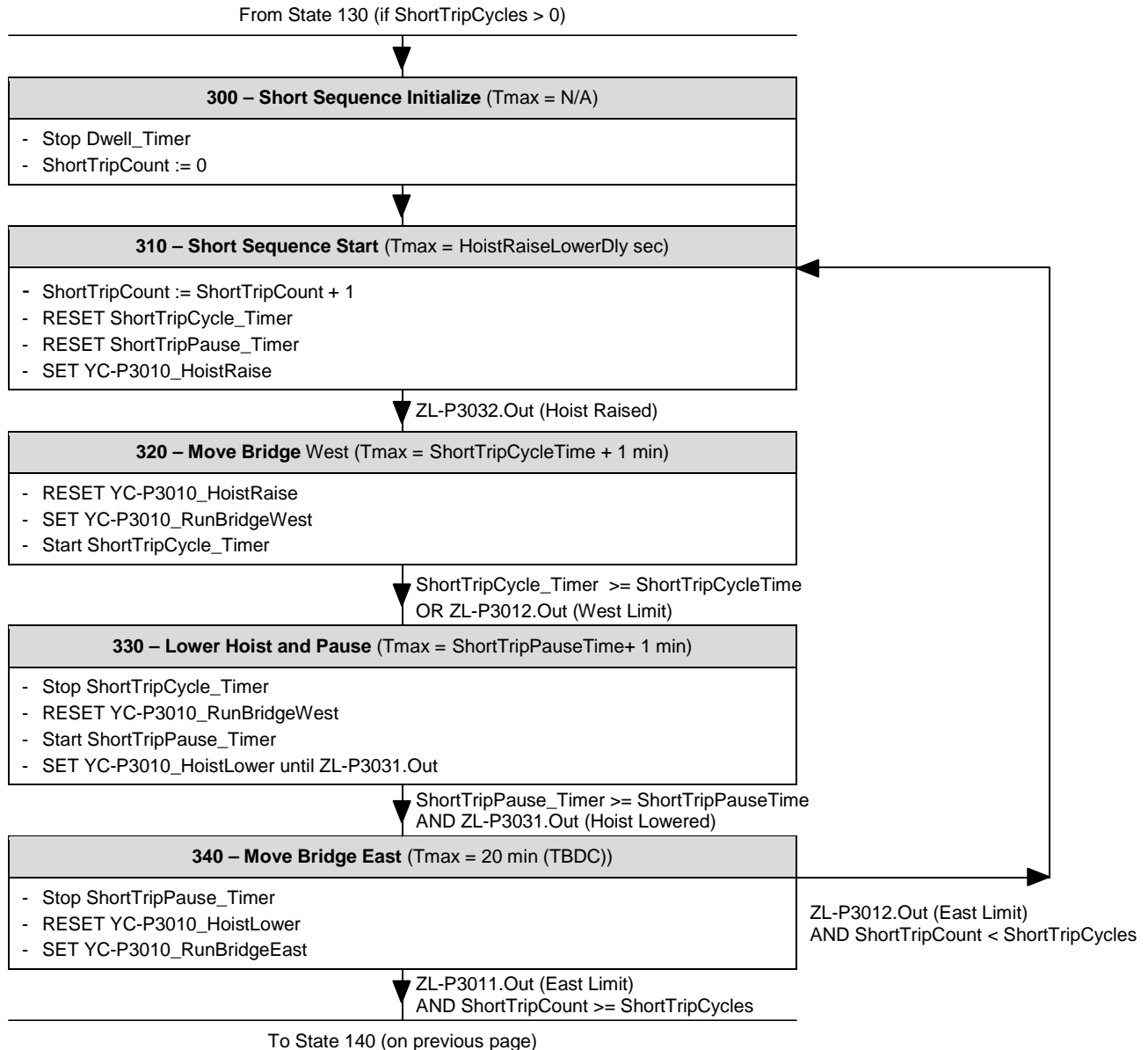

	FUNCTIONAL REQUIREMENTS SPECIFICATION	Document Code: A-0102-AFRS-P002
		Revision: 0
Client: City of Winnipeg	Project: Primary Clarifiers Travelling Bridges Refurbishment	Package / Area: PLC-P311

3.2.1.3 Short Cycle Sequence



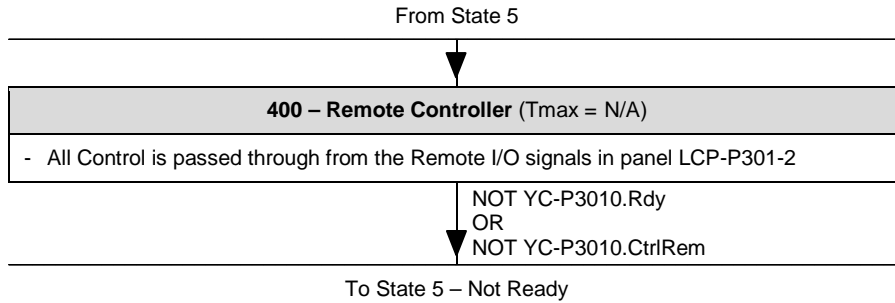

	FUNCTIONAL REQUIREMENTS SPECIFICATION	Document Code: A-0102-AFRS-P002
		Revision: 0
Client: City of Winnipeg	Project: Primary Clarifiers Travelling Bridges Refurbishment	Package / Area: PLC-P311

3.2.1.4 Remote Controller Control

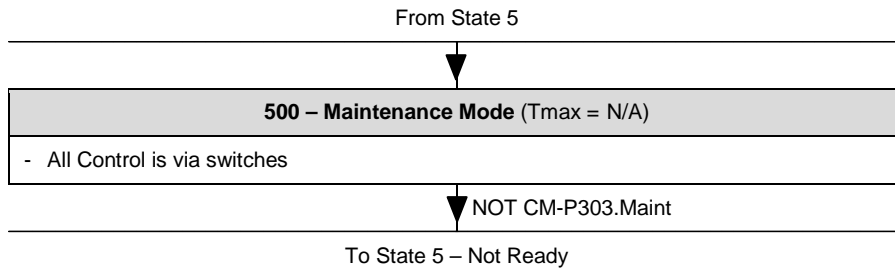

3.2.1.5 Maintenance Mode



	FUNCTIONAL REQUIREMENTS SPECIFICATION	Document Code: A-0102-AFRS-P002
		Revision: 0
Client: City of Winnipeg	Project: Primary Clarifiers Travelling Bridges Refurbishment	Package / Area: PLC-P311

3.2.1.6 Alarm Lockouts

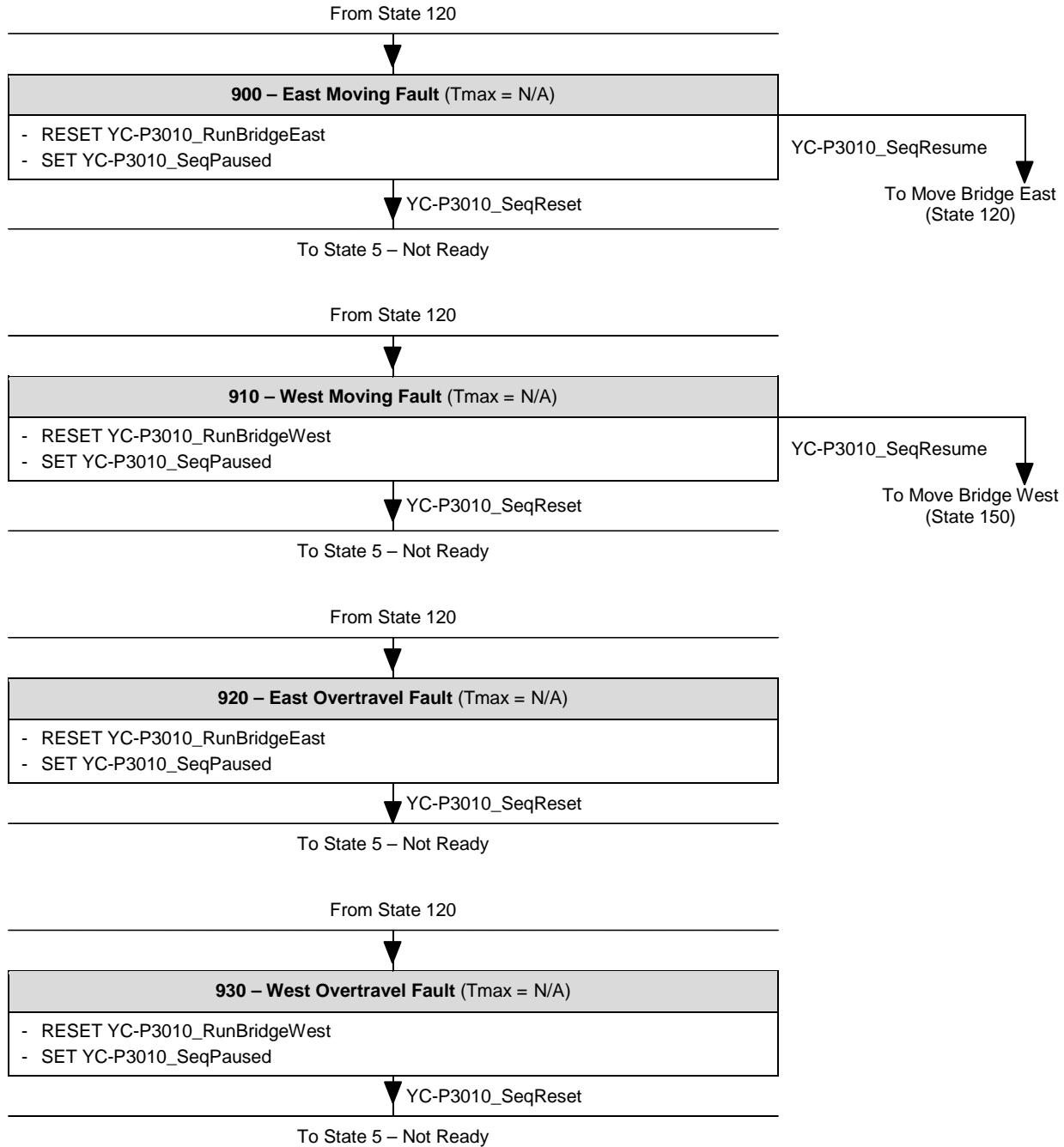

	FUNCTIONAL REQUIREMENTS SPECIFICATION	Document Code: A-0102-AFRS-P002
		Revision: 0
Client: City of Winnipeg	Project: Primary Clarifiers Travelling Bridges Refurbishment	Package / Area: PLC-P311

Table 3.2-3 YC-P3010_SeqFail / Clarifier 1 Travelling Bridge Sequence Fail

Instance	YC-P3010_SeqFail		
Class	DiscretelA		
Inputs	Parameter	Source	Type
	ExtRst	YC-P3010.RstDevAlms	Link
	In	See YC-P3010_Sequence Above	Link
Alarms	Alm(3) - Low Priority		

Table 3.2-4 YC-P3010_BridgeDrive / TBC-P301 Clarifier 1 Travelling Bridge Drive

Instance	YC-P3010_BridgeDrive		
Class	DiscreteCS_FwdRev		
Inputs	Parameter	Source	Type
	RunFbkDly	15 000 ms	Const
	CtrlRem	TBC-P301.Rem	I/O
	Flt	TBC-P301.Flt ¹	I/O
	PathNotRunRdyInFwd	ZL-P3011.Out	Link
	PathNotRunRdyInRev	ZL-P3012.Out	Link
	RunReqNoPathDly	1 sec	Const
	RunFwd	TBC-P301.RunEast	I/O
	RunRev	TBC-P301.RunWest	I/O
	RunFwdAuto	YC-P3010_CmdRunEast	Link
	RunRevAuto	YC-P3010_CmdRunWest	Link
	RestartDly	0 sec	Const
Outputs Destinations	Parameter	Destination	Type
	CmdStartFwd	TBC-P301.CmdRunEast	I/O
	CmdStartRev	TBC-P301.CmdRunWest	I/O
Alarms	Priority as per class		

Note: Forward moves bridge in the East direction; Reverse moves it West towards the home position

¹ Motor overload, or bridge has travelled past east or west limit



	FUNCTIONAL REQUIREMENTS SPECIFICATION	Document Code: A-0102-AFRS-P002
		Revision: 0
Client: City of Winnipeg	Project: Primary Clarifiers Travelling Bridges Refurbishment	Package / Area: PLC-P311

Table 3.2-5 YC-P3030_BridgeHoist / CM-P303 Clarifier 1 Travelling Bridge Hoist

Instance	YC-P3030_BridgeHoist		
Class	DiscreteCS_FwdRev		
Inputs	Parameter	Source	Type
	RunFbkDly	20 000 ms	Const
	CtrlRem	CM-P303.Rem	I/O
	Flt	(See additional logic)	Link
	PathNotRunRdyInFwd	ZL-P3032.Out	Link
	PathNotRunRdyInRev	ZL-P3031.Out	Link
	RunReqNoPathDly	1 Sec	Const
	RunFwd	CM-P303.RunRaise	I/O
	RunRev	CM-P303.RunLower	I/O
	RunFwdAuto	YC-P3010_CmdRaise	Link
	RunRevAuto	YC-P3010_CmdLower	Link
	RestartDly	0 sec	Const
Outputs Destinations	Parameter	Destination	Type
	CmdStartFwd	CM-P303.CmdRaise	I/O
	CmdStartRev	CM-P303.CmdLower	I/O
Alarms	Priority as per class		
Additional Logic	Set Flt if CmdStartFwd is true for more than YC-P3010_HoistRaiseLowerDly consecutively. Set Flt if CmdStartRev is true for more than YC-P3010_HoistRaiseLowerDly consecutively.		

Note: Forward raises the hoist; Reverse lowers it.

	FUNCTIONAL REQUIREMENTS SPECIFICATION	Document Code: A-0102-AFRS-P003
		Revision: 0
Client: City of Winnipeg	Project: Primary Clarifiers Travelling Bridges Refurbishment	Package / Area: PLC-P302

Prepared By: DUSTIN WILSON		2018-08-28
Name	Signature	Date
Checked By: JASON BOUCHARD		2018-08-28
Name	Signature	Date
Approved By: DUSTIN WILSON		2018-08-28
Name	Signature	Date

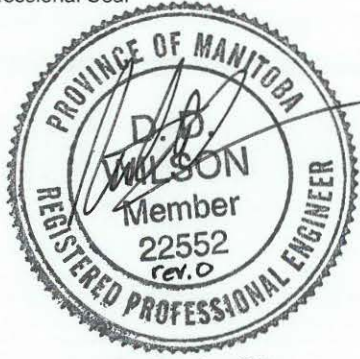
<p>Certificate of Authorization</p> <div style="border: 1px solid black; padding: 10px; text-align: center;">  <p>ENGINEERS GEOSCIENTISTS MANITOBA</p> <p>Certificate of Authorization</p> <p>KGS Group</p> <p>No. 245</p> </div>	<p>Professional Seal</p> <div style="text-align: center;">  <p>2018-08-28</p> </div>
--	---

REVISION REGISTER					
Rev.	Description	Date	By	Checked	Approved
0	Issued for Use	2018-08-28	D. Wilson	J. Bouchard	D. Wilson



	FUNCTIONAL REQUIREMENTS SPECIFICATION	Document Code: A-0102-AFRS-P003
		Revision: 0
Client: City of Winnipeg	Project: Primary Clarifiers Travelling Bridges Refurbishment	Package / Area: PLC-P302

Table of Contents

1	Overview.....	3
1.1	Associated Documents	3
2	General Requirements.....	5
2.1	Human Machine Interface.....	5
2.1.1	Screen Layout.....	5
2.1.2	Graphic Displays.....	5
2.2	Inputs from Other PLCs	6
2.3	Logic and variables for other PLCs.....	6
3	Implementation	7
3.1	Simple Class Instances.....	7
3.1.1	DiscreteIA (Discrete Indication and / or Alarming).....	7
3.2	P4 – Travelling Bridges.....	8
3.2.1	Clarifier 2 Travelling Bridge Collector	8

	FUNCTIONAL REQUIREMENTS SPECIFICATION	Document Code: A-0102-AFRS-P003
		Revision: 0
Client: City of Winnipeg	Project: Primary Clarifiers Travelling Bridges Refurbishment	Package / Area: PLC-P302

1 OVERVIEW

The logic specified in this document is intended to provide functional requirements for PLC-P302 for the Primary Clarifier 2 Travelling Bridge. Refer to document A-0102-AFRS-A001 for general requirements and standard equipment classes. It is written from a technical perspective, and is intended to be read along with the associated Process & Instrument Diagram (P&ID) drawings.

This Functional Requirement Specification (FRS) document is intended to provide an initial basis for development of the PLC and HMI application functionality for the specific process area described herein. The Contractor must provide further development of the PLC and HMI functionality described in this document for a complete and functional system. It is written from a technical perspective and is intended to be read in parallel with the Process Control Narratives (PCNs), the associated Process and Instrument Diagrams (P&IDs), the Instrument Loop Drawings (ILDs) and the other PLC related contract documents. In the event of any discrepancy or any ambiguity, the PCNs, P&IDs, ILDs and other contract documents take precedence (in no specific order of importance) over the FRS documents. Any significant discrepancy should be clarified with the Contract Administrator. All discrepancy resolutions should be documented and submitted as part of the as-built markups. If there are discrepancies from a scope of work perspective, the more stringent requirement shall apply. All scope of work discrepancies should be clarified with the Contract Administrator.

Control functions are described using pseudo code and encapsulated in classes (some of which are commonly applicable for similar or identical equipment systems). These classes may therefore be instantiated as necessary to control similar types of equipment throughout the facility. Each class defines a control interface whose inputs and outputs are interconnected to implement the overall process control strategy as defined by the PCNs, P&IDs, ILDs, etc. and the FRS document. The specific area FRS documents are supported by the General FRS document which provides common definitions for software development required throughout the entire facility.

While the FRS documents provide specific guidance with respect to software development, they should not be presumed to be comprehensive of all software development requirements. Ultimately the P&IDs, the PCNs and the ILDs will govern and take precedence. It is the responsibility of the Contractor to utilize its expertise to provide a fully functional set of developed software in accordance with the contract documents even if not described within the FRS document at no additional cost to the contract. It is the specific responsibility of the Contractor to identify, seek clarification and ultimately resolve any issues of ambiguity, interpretation, uncertainties or discrepancies between the FRS documents and the associated contract documents. This responsibility extends to the need for consultation, as necessary, with the process designers, process equipment vendors, the Engineer, the Owner and any other relevant stakeholders to resolve any issue in accordance with the Contractor's legal obligations for the delivery of the work.

1.1 Associated Documents

The documents and drawings associated with this functional requirements specification are listed below. Additional P&ID drawings may be referenced in this document.

Document / Drawing Number	Description
1-0102-AFRS-A001	FUNCTIONAL REQUIREMENTS SPECIFICATION
612620-0014-40ER-0001	TAG NAMING STANDARD
612620-0015-40ER-0001	HMI LAYOUT AND AUTOMATION PLAN
1-0102-PPID-P401	PROCESS AND INSTRUMENTATION DIAGRAM – CLARIFIER 1 TRAVELLING BRIDGE COLLECTOR

	FUNCTIONAL REQUIREMENTS SPECIFICATION	Document Code: A-0102-AFRS-P003
		Revision: 0
Client: City of Winnipeg	Project: Primary Clarifiers Travelling Bridges Refurbishment	Package / Area: PLC-P302

Document / Drawing Number	Description
1-0102-AILD-P306 SHT. 001	LOOP DIAGRAM – RIO-P302 INPUTS / RIO-P800-2 OUTPUTS
1-0102-AILD-P306 SHT. 002	LOOP DIAGRAM – RIO-P302 INPUTS / RIO-P800-2 OUTPUTS
1-0102-AILD-P307 SHT. 001	LOOP DIAGRAM – RIO-P302 OUTPUTS / RIO-P800-2 INPUTS
1-0102-AILD-P307 SHT. 002	LOOP DIAGRAM – RIO-P302 OUTPUTS / RIO-P800-2 INPUTS
1-0102-ACBD-P305 SHT. 001	CABINET LAYOUT - PRIMARY CLARIFIERS - LCP-P302, TRAVELLING BRIDGE PLC CABINET - PLC-P302-1
1-0102-ACBD-P306 SHT. 001	POWER DISTRIBUTION SCHEMATIC - PRIMARY CLARIFIERS - LCP-P302-1, TRAVELLING BRIDGE PLC CABINET - PLC-301
1-0102-ACBD-P306 SHT. 002	POWER DISTRIBUTION SCHEMATIC - PRIMARY CLARIFIERS - LCP-P302-1, TRAVELLING BRIDGE PLC CABINET - PLC-301 - SHEET 002
1-0102-ACBD-P307 SHT. 001	WIRING DIAGRAM - PRIMARY CLARIFIERS - LCP-P302, LCP-P302-1, PLC-P302 - DISCRETE INPUTS
1-0102-ACBD-P308 SHT. 001	WIRING DIAGRAM - PRIMARY CLARIFIERS - LCP-P302, LCP-P302-1, PLC-P302 - DISCRETE OUTPUTS
1-0102-ACBD-P317 SHT. 001	CABINET LAYOUT - PRIMARY CLARIFIERS - LCP-P302-2, TRAVELLING BRIDGE PLC CABINET - RIO-P302
1-0102-ACBD-P318 SHT. 001	POWER DISTRIBUTION SCHEMATIC - PRIMARY CLARIFIERS - LCP-P302-2, TRAVELLING BRIDGE PLC CABINET - RIO-P302
1-0102-ACBD-P318 SHT. 002	POWER DISTRIBUTION SCHEMATIC - PRIMARY CLARIFIERS - LCP-P302-2, TRAVELLING BRIDGE PLC CABINET - RIO-301 - SHEET 002
1-0102-ACBD-P319 SHT. 001	WIRING DIAGRAM - PRIMARY CLARIFIERS - LCP-P302-2, RIO-P302 - DISCRETE INPUTS
1-0102-ACBD-P320 SHT. 001	WIRING DIAGRAM - PRIMARY CLARIFIERS - LCP-P302-1, PLC-P302 - DISCRETE OUTPUTS
1-0102-EGAD-P003 SHT. 001	POWER AND INSTRUMENTATION - MAIN FLOOR PLAN - PRIMARY CLARIFIER 1 & 2 ELEV 234.39M
1-0102-EMCL-P302 SHT. 001	MOTOR STARTER SCHEMATIC - TBC-P302 - PRIMARY CLARIFIER 2 TRAVELLING BRIDGE COLLECTOR
1-0102-EMCL-P302 SHT. 002	MOTOR STARTER SCHEMATIC - TBC-P302 - PRIMARY CLARIFIER 2 TRAVELLING BRIDGE COLLECTOR - SHEET 002
1-0102-EMCL-P304 SHT. 001	MOTOR STARTER SCHEMATIC - CM-P304 - PRIMARY CLARIFIER 2 COLLECTOR MECHANISM
1-0102-EMCL-P304 SHT. 002	MOTOR STARTER SCHEMATIC - CM-P304 - PRIMARY CLARIFIER 2 COLLECTOR MECHANISM
1-0102-ANET-P003 SHT. 005	NETWORK DIAGRAM - PRIMARY CLARIFIERS - DEVICE NETWORK
1-0102-ANET-P003 SHT. 006	NETWORK DIAGRAM - PRIMARY CLARIFIERS - DEVICE NETWORK

	FUNCTIONAL REQUIREMENTS SPECIFICATION	Document Code: A-0102-AFRS-P003
		Revision: 0
Client: City of Winnipeg	Project: Primary Clarifiers Travelling Bridges Refurbishment	Package / Area: PLC-P302

2 GENERAL REQUIREMENTS

Refer to document A-0102-AFRS-A001 for general requirements and standard classes.

2.1 Human Machine Interface

2.1.1 Screen Layout

The typical screen layout for the HMI graphic terminal shall be as shown in Figure 1. Navigation buttons shall reside across the bottom, a single-line alarm banner across the top, and the remainder of the screen allocated for the graphic display area. The graphic display area will be utilized for mimic displays, configuration screens, trends, and an alarm summary.

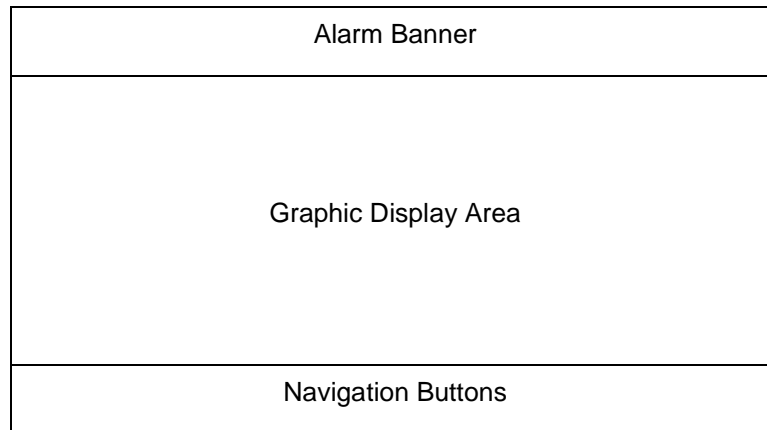

Figure 1: Screen Layout

2.1.2 Graphic Displays

Create Area Overview, Process Graphic and Detail displays as per City of Winnipeg HMI Layout and Animation plan document (612620-0015-40ER-0001) and General Functional Requirements Specification A-0102-AFRS-A001.

The following tables provide guidance on the minimum anticipated groupings of process displays, however, these should not be considered as fully defined, and modifications and additions may be required.

Note that only major or representative equipment and devices are explicitly shown in the graphic display tables. Include other devices as required for a complete HMI.

Refer to General Functional Requirements Specification A-0102-AFRS-A001 for Level 1 graphics.

Table 2.1-1 Level 2 Area P Graphic Displays – Primary Clarifier Overview

Group	Content
<ul style="list-style-type: none"> • Primary Clarifier 	TBC-P302 Clarifier 1 Travelling Bridge Collector Status <ul style="list-style-type: none"> - Bridge Sequence Status - Travelling Bridge Drive TBC-P302 Status - Sludge / Scum Scraper Hoist CM-P304 Status

	FUNCTIONAL REQUIREMENTS SPECIFICATION	Document Code: A-0102-AFRS-P003
		Revision: 0
Client: City of Winnipeg	Project: Primary Clarifiers Travelling Bridges Refurbishment	Package / Area: PLC-P302

Table 2.1-2 L3 and L4 Graphic Displays

Display Group	Level	Content
PCS Status	4	PLC Status and Basic Diagnostics for <ul style="list-style-type: none"> • Main Controller Rack • Remote I/O Rack • Networking Components (Including switch diagnostic when available) • Power Supplies
Overview Trends	4	(See Trends section below)

2.2 Inputs from Other PLCs

Some variables will be shared among different areas of the plant. They will be communicated via the Fibre Ethernet redundant ring connecting the PLCs. Variables that are read from other PLCs are listed below, along with their default value in the event of a communication failure.

The following table provides guidance on the minimum anticipated variables that are read from other PLC along with their default value in the event of a communication failure, however, these should not be considered as fully defined and modifications and additions may be required.

Input	Description	Source PLC	Value On Communication Error
T.B.D.	T.B.D.	T.B.D.	T.B.D.

2.3 Logic and variables for other PLCs

The following sections provide guidance on the minimum anticipated variables and logic required from this PLC for other PLCs, however, these should not be considered as fully defined and modifications and additions may be required.

Variable	Description	Source
PLC-P302_DiscreteInputTable	Pre-defined table for all discrete inputs	PLC-P302
PLC-P302_DiscreteOutputTable	Pre-defined table for all discrete outputs	PLC-P302
PLC-P302_AnalogInputTable	Pre-defined table for all analog inputs	PLC-P302
PLC-P302_AnalogOutputTable	Pre-defined table for all analog outputs	PLC-P302
PLC-P302_DiscreteStatusTable	Table to store discrete status information to be monitored remotely	PLC-P302
PLC-P302_IntegerTable	Table to store integer information to be monitored remotely	PLC-P302
PLC-P302_FloatingPointTable	Table to store floating point information to be monitored remotely	PLC-P302

Note: All Pre-defined tables shall include share space for the addition of two additional I/O modules.

	FUNCTIONAL REQUIREMENTS SPECIFICATION	Document Code: A-0102-AFRS-P003
		Revision: 0
Client: City of Winnipeg	Project: Primary Clarifiers Travelling Bridges Refurbishment	Package / Area: PLC-P302

3 IMPLEMENTATION

3.1 Simple Class Instances

The following tables show simple class instance implementations, other instances are shown in the rest of the document. In general, equipment with identical functionality for different systems is not explicitly shown.

3.1.1 DiscretelA (Discrete Indication and / or Alarming)

Table 3.1-1 Simple DiscretelA Instances

Instance	Source	Description	Alarms (Priority)	Notes
ZL-P3021	ZS-P3021	Clarifier 1 Bridge Drive TBC-P302 at East Position	Err(2)	P&ID: PPID-P401
ZL-P3022	ZS-P3022	Clarifier 1 Bridge Drive TBC-P302 at West Position	Err(2)	P&ID: PPID-P401
ZL-P3023	ZS-P3023	Clarifier 1 Bridge Drive TBC-P302 at East Overtravel Position	Err(2)	P&ID: PPID-P401
ZL-P3024	ZS-P3024	Clarifier 1 Bridge Drive TBC-P302 at West Overtravel Position	Err(2)	P&ID: PPID-P401
ZLL-P3041	CM-P304-ZSL	Clarifier 1 Scraper Hoist CM-P304 Lowered	Err(2)	P&ID: PPID-P401
ZLH-P3042	CM-P304-ZSH	Clarifier 1 Scraper Hoist CM-P304 Raised	Err(2)	P&ID: PPID-P401

	FUNCTIONAL REQUIREMENTS SPECIFICATION	Document Code: A-0102-AFRS-P003
		Revision: 0
Client: City of Winnipeg	Project: Primary Clarifiers Travelling Bridges Refurbishment	Package / Area: PLC-P302

3.2 P4 – Travelling Bridges

3.2.1 Clarifier 2 Travelling Bridge Collector

P&ID Drawing: PPID-P402

3.2.1.1 Clarifier 2 Travelling Bridge Control

The bridge travels East and West across the clarifier. As it travels East, the hoist will be lowered to scrape sludge to the sludge auger, and as it travels West, the hoist will be raised to push scum into the scum trough.

When the bridge reaches the West end of the clarifier (home position), it will wait for WaitTime minutes before moving East across the clarifier. Similarly, at the East end, the bridge will wait for DwellTime minutes before moving West across the clarifier. However, from the East end, the clarifier may either make a long trip (returning all the way to the West end), or a short trip, where it travels West for ShortTripCycleTime, then pauses for ShortTripPauseTime, before returning to the East end of the clarifier. This process repeats ShortTripCount times, after which the bridge travels all the way back to the West end of the clarifier.

Inputs From the HMI

Setting	Description	Initial Value	Range
HoistRaiseLowerDly	Time to allow hoist to completely raise or lower	20 sec	0 - 100 sec
DwellTime	Bridge Dwell Time (East End)	5 min	0 - 30 min
ShortTripCycles	Number of short trip from east end of clarifier	6 cycles	0 – 100 cycles
ShortTripCycleTime	Length of each short trip	10 min	0 - 60 min
ShortTripPauseTime	Pause length at the end of each short trip	6 min	0 - 60 min
WaitTime	Bridge Wait Time (West End)	6 min	0 - 30 min
SeqResume	Resume Sequence from Paused State		

Note: Perform range checking on all HMI settings inputs to ensure that they are valid.
Prefix all alarm identifiers with "YC-P3020_"

Outputs for Display on HMI

Output	Description
SeqRdy	All bridge components are in remote auto mode

	FUNCTIONAL REQUIREMENTS SPECIFICATION	Document Code: A-0102-AFRS-P003
		Revision: 0
Client: City of Winnipeg	Project: Primary Clarifiers Travelling Bridges Refurbishment	Package / Area: PLC-P302

SeqRunning	Bridge trip cycle is currently running
SeqPaused	Bridge trip cycle is currently paused
ShortTripCount	Number of short trips that have occurred in the current cycle
ShortTripTimeDisp	Amount of time elapsed in current short trip (ShortTripCycle_Timer)
ShortTripPauseDisp	Amount of time elapsed in current short trip pause (ShortTripPause_Timer)
TimeAtEast	Time elapsed in current Dwell time at East end of Clarifier (Dwell_Timer)
TimeAtWest	Time elapsed in current Wait time at West end of Clarifier (Wait_Timer)

Note: Prefix all identifiers with "YC-P3020_"

Table 3.2-1 YC-P3020_ ShortTripMode / Bridge West Direction Trip Length Selector

Instance	YC-P3020_ ShortTripMode		
Class	OnOffSel		
Inputs	Parameter	Source	Type
	SelOffText	"Long Trips"	Const
	SelOnText	"Short Trips"	Const

Table 3.2-2 YC-P3020 Clarifier 2 Travelling Bridge Control Station

Instance	YC-P3020		
Class	DiscreteCS		
Inputs	Parameter	Source	Type
	CtrlRem	N/A	Link
	CtrlLoc	N/A	Link
	Flt	YC-P3020_SeqFail.Out	Link
	RdyIn	NOT YC-P3020_SeqStopCond	Link
	Run	YC-P3020_SeqRunning	Link
	RunAuto	YC-P3020_SeqRdy OR YC-P3020.Running	Link
	StartInh	YC-P3020_SeqStopCond	Link
Alarms	(2)		

Note: Alarm priority as per default class definition or as shown

Sequence Ready Logic

YC-P3020_SeqRdy := YC-P3020_BridgeDrive.Rdy AND YC-P3040_BridgeHoist.Rdy AND NOT(CM-P304.Maint)

	FUNCTIONAL REQUIREMENTS SPECIFICATION	Document Code: A-0102-AFRS-P003
		Revision: 0
Client: City of Winnipeg	Project: Primary Clarifiers Travelling Bridges Refurbishment	Package / Area: PLC-P302

Sequence Stop Conditions

Set YC-P3020_SeqStopCond and stop the travelling bridge sequence (by immediately going to State 5 in the sequence) if ANY of the following stop conditions are true:

- NOT YC-P3020_SeqRdy (Sequence not ready)
- YC- P3020_SeqFail.In (Sequence fault condition)
- NOT YC-P3020.CmdRun AND YC-P3020.Running

Sequence Fault Conditions

Set YC-P3020_SeqFail if ANY of the following conditions are true:

- Any step in the sequence is active for longer than Tmax seconds, where Tmax is the maximum time allowed for a given step (See Sequence for Sludge Transfer below)

Set YC-P3020_EastMoveFault if ANY of the following conditions are true:

- Loss of Hoist Lowered Limit Switch (ZL-P3041.Out) for Tdelay seconds, where Tdelay is a time delay of 1-5 seconds.

Set YC-P3020_WestMoveFault if ANY of the following conditions are true:

- Loss of Hoist Raised Limit Switch (ZL-P3042.Out) for Tdelay seconds, where Tdelay is a time delay of 1-5 seconds.

	FUNCTIONAL REQUIREMENTS SPECIFICATION	Document Code: A-0102-AFRS-P003
		Revision: 0
Client: City of Winnipeg	Project: Primary Clarifiers Travelling Bridges Refurbishment	Package / Area: PLC-P302

3.2.1.2 YC-P3020_Sequence / Clarifier 2 Travelling Bridge Sequence

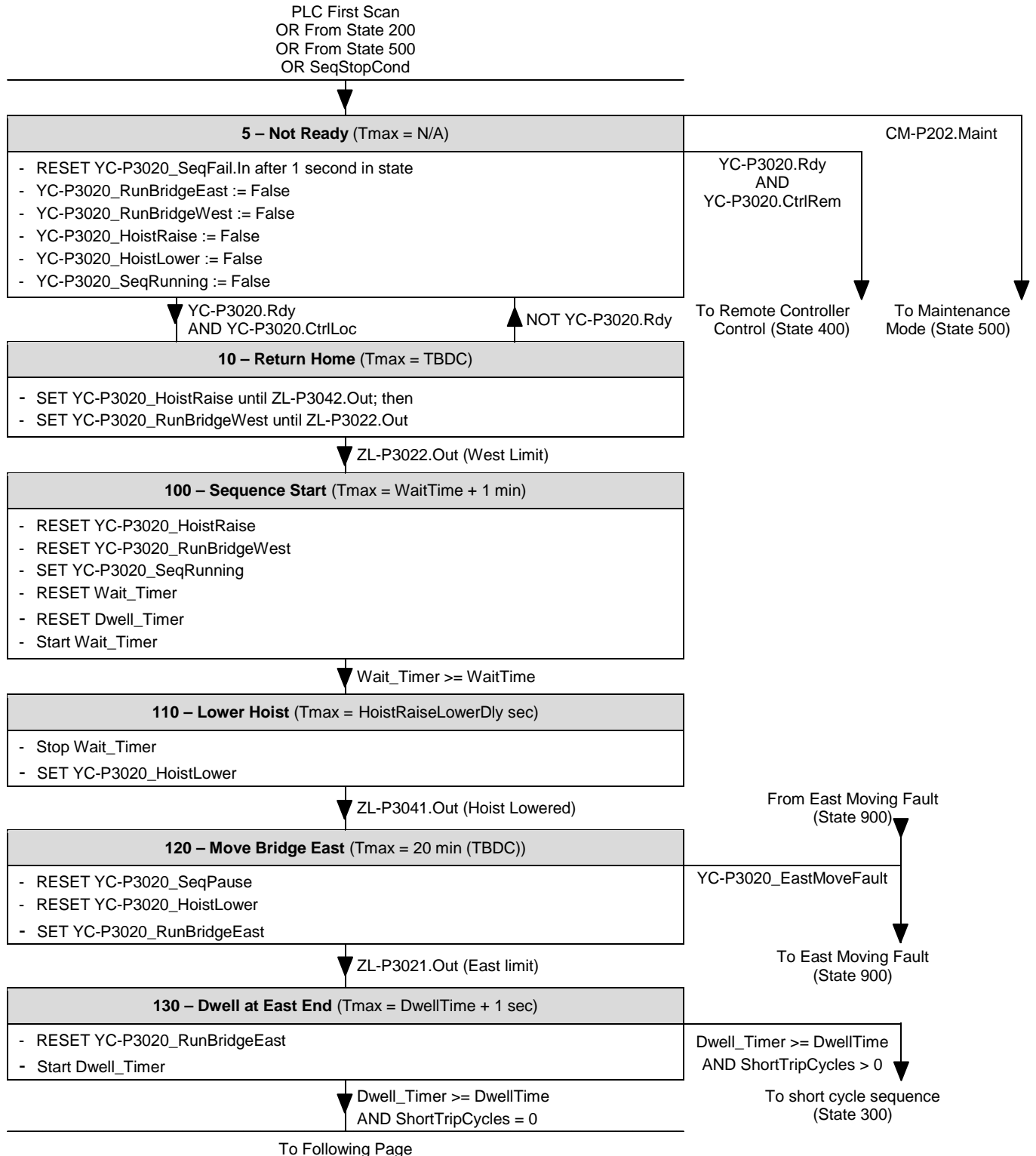

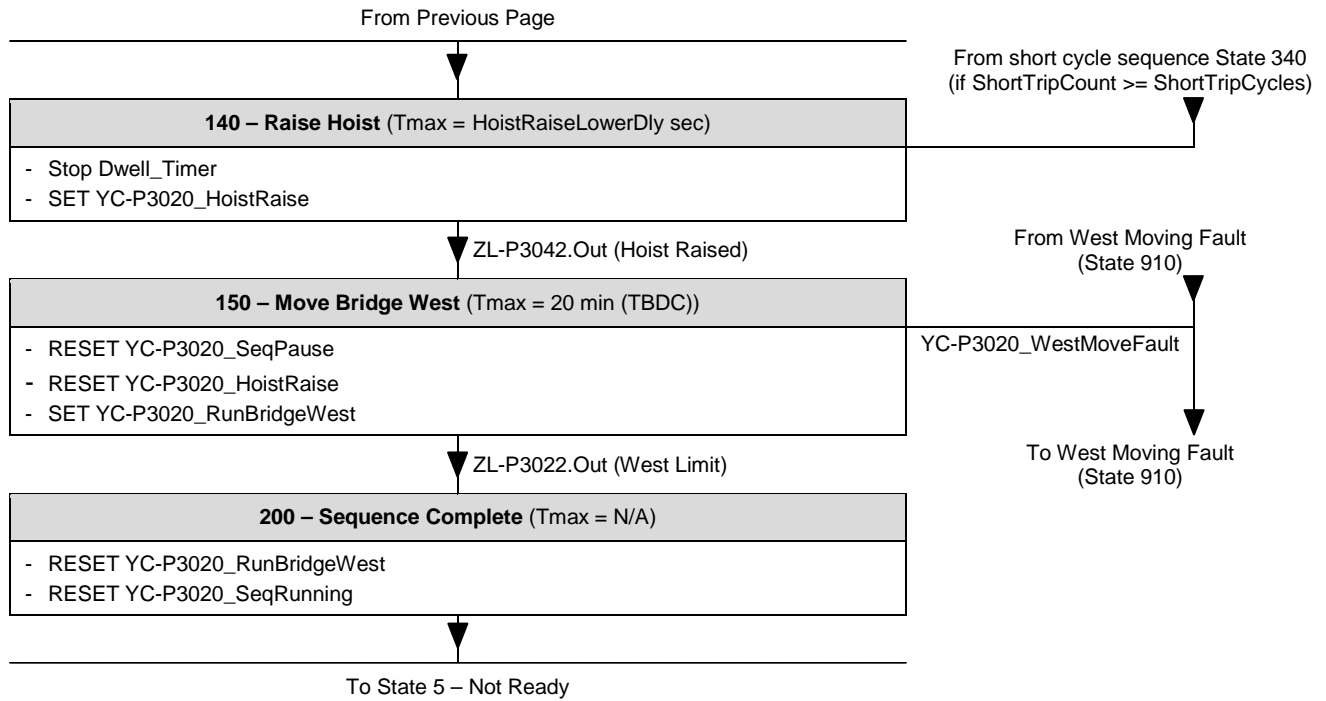

	FUNCTIONAL REQUIREMENTS SPECIFICATION	Document Code: A-0102-AFRS-P003
		Revision: 0
Client: City of Winnipeg	Project: Primary Clarifiers Travelling Bridges Refurbishment	Package / Area: PLC-P302

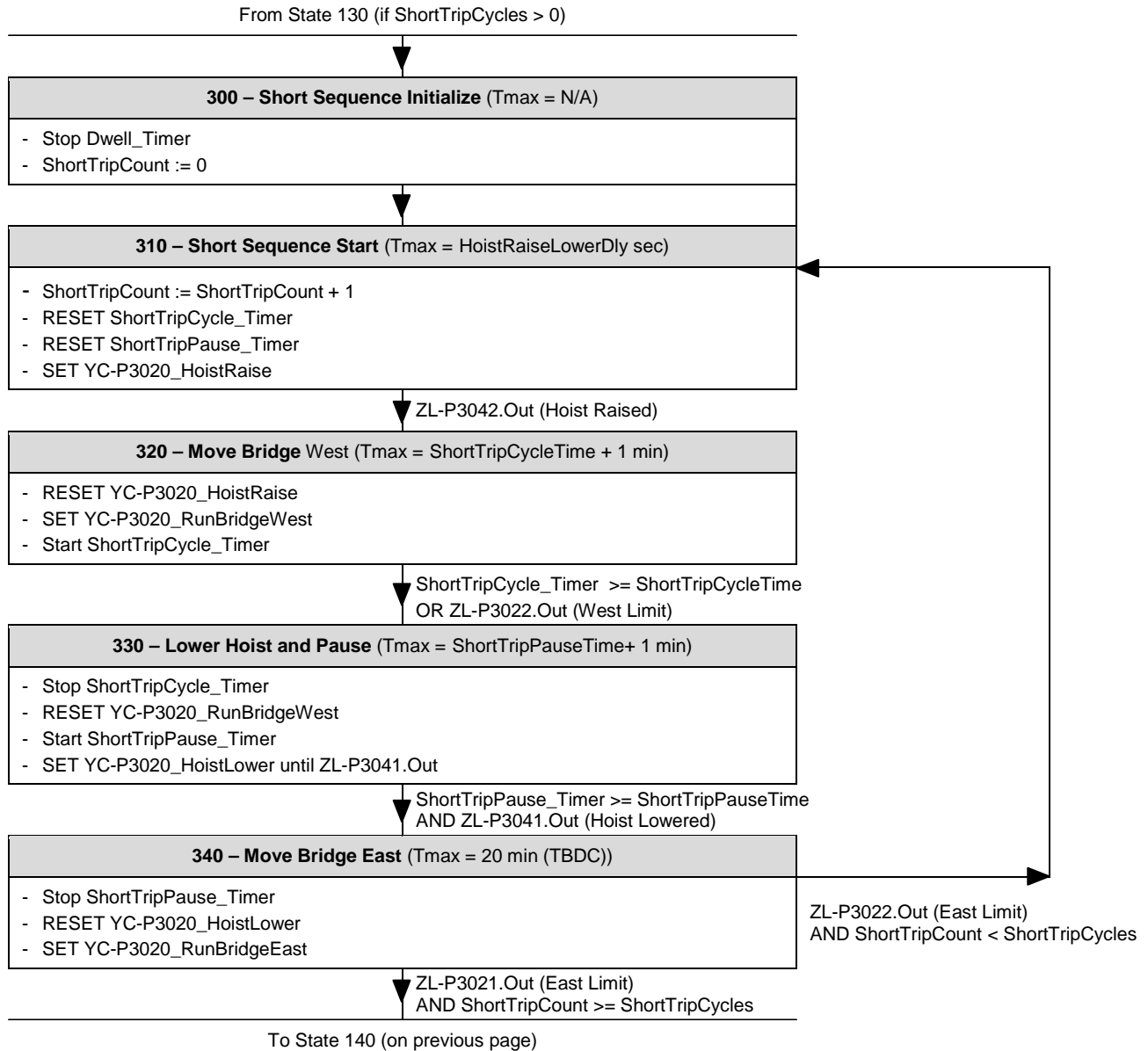

	FUNCTIONAL REQUIREMENTS SPECIFICATION	Document Code: A-0102-AFRS-P003
		Revision: 0
Client: City of Winnipeg	Project: Primary Clarifiers Travelling Bridges Refurbishment	Package / Area: PLC-P302

3.2.1.3 Short Cycle Sequence



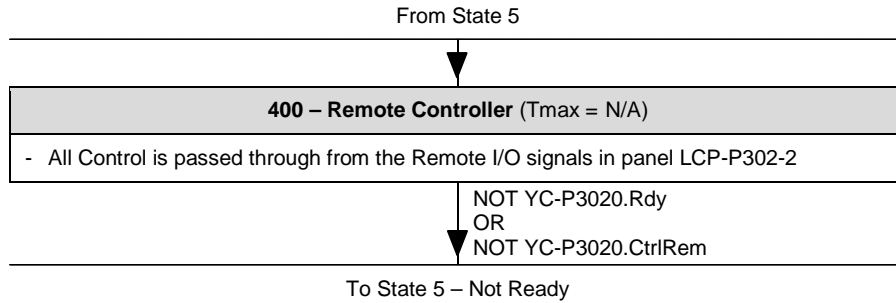

	FUNCTIONAL REQUIREMENTS SPECIFICATION	Document Code: A-0102-AFRS-P003
		Revision: 0
Client: City of Winnipeg	Project: Primary Clarifiers Travelling Bridges Refurbishment	Package / Area: PLC-P302

3.2.1.4 Remote Controller Control

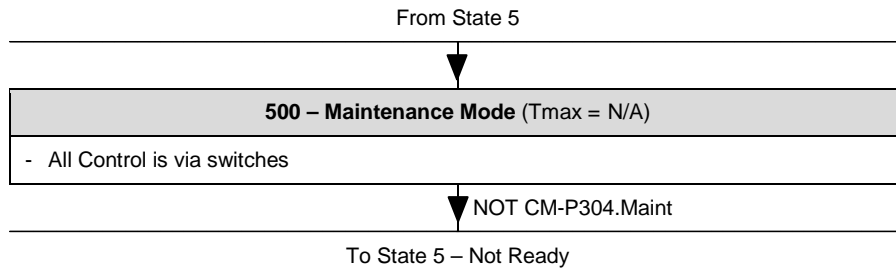

3.2.1.5 Maintenance Mode



	FUNCTIONAL REQUIREMENTS SPECIFICATION	Document Code: A-0102-AFRS-P003
		Revision: 0
Client: City of Winnipeg	Project: Primary Clarifiers Travelling Bridges Refurbishment	Package / Area: PLC-P302

3.2.1.6 Alarm Lockouts

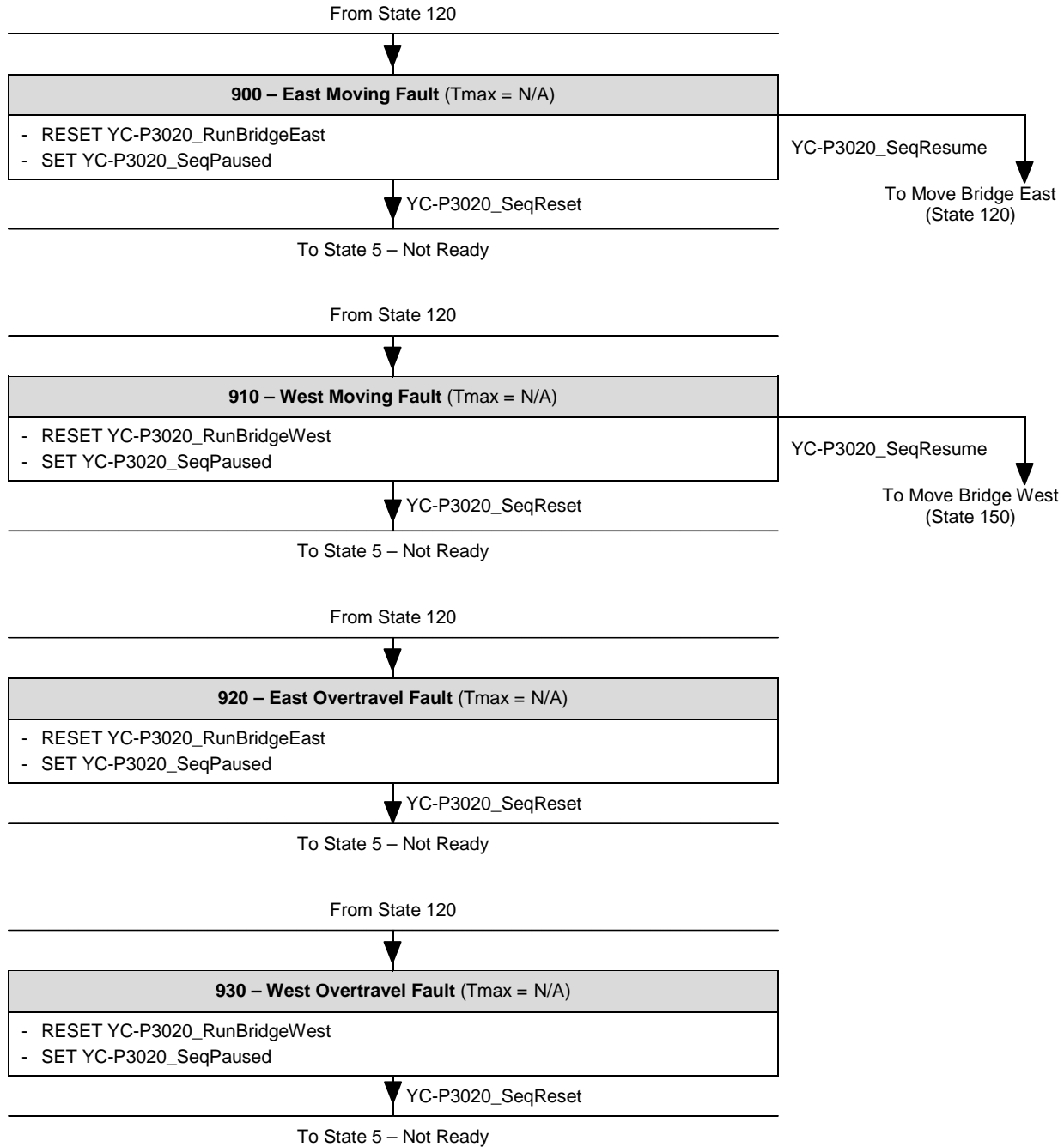

	FUNCTIONAL REQUIREMENTS SPECIFICATION	Document Code: A-0102-AFRS-P003
		Revision: 0
Client: City of Winnipeg	Project: Primary Clarifiers Travelling Bridges Refurbishment	Package / Area: PLC-P302

Table 3.2-3 YC-P3020_SeqFail / Clarifier 2 Travelling Bridge Sequence Fail

Instance	YC-P3020_SeqFail		
Class	DiscretelA		
Inputs	Parameter	Source	Type
	ExtRst	YC-P3020.RstDevAlms	Link
	In	See YC-P3020_Sequence Above	Link
Alarms	Alm(3) - Low Priority		

Table 3.2-4 YC-P3020_BridgeDrive / TBC-P302 Clarifier 2 Travelling Bridge Drive

Instance	YC-P3020_BridgeDrive		
Class	DiscreteCS_FwdRev		
Inputs	Parameter	Source	Type
	RunFbkDly	15 000 ms	Const
	CtrlRem	TBC-P302.Rem	I/O
	Flt	TBC-P302.Flt ¹	I/O
	PathNotRunRdyInFwd	ZL-P3021.Out	Link
	PathNotRunRdyInRev	ZL-P3022.Out	Link
	RunReqNoPathDly	1 sec	Const
	RunFwd	TBC-P302.RunEast	I/O
	RunRev	TBC-P302.RunWest	I/O
	RunFwdAuto	YC-P3020_CmdRunEast	Link
	RunRevAuto	YC-P3020_CmdRunWest	Link
	RestartDly	0 sec	Const
Outputs Destinations	Parameter	Destination	Type
	CmdStartFwd	TBC-P302.CmdRunEast	I/O
	CmdStartRev	TBC-P302.CmdRunWest	I/O
Alarms	Priority as per class		

Note: Forward moves bridge in the East direction; Reverse moves it West towards the home position

¹ Motor overload, or bridge has travelled past east or west limit





	FUNCTIONAL REQUIREMENTS SPECIFICATION	Document Code: A-0102-AFRS-P003
		Revision: 0
Client: City of Winnipeg	Project: Primary Clarifiers Travelling Bridges Refurbishment	Package / Area: PLC-P302



Table 3.2-5 YC-P3040_BridgeHoist / CM-P304 Clarifier 2 Travelling Bridge Hoist

Instance	YC-P3040_BridgeHoist		
Class	DiscreteCS_FwdRev		
Inputs	Parameter	Source	Type
	RunFbkDly	20 000 ms	Const
	CtrlRem	CM-P304.Rem	I/O
	Flt	(See additional logic)	Link
	PathNotRunRdyInFwd	ZL-P3042.Out	Link
	PathNotRunRdyInRev	ZL-P3041.Out	Link
	RunReqNoPathDly	1 Sec	Const
	RunFwd	CM-P304.RunRaise	I/O
	RunRev	CM-P304.RunLower	I/O
	RunFwdAuto	YC-P3020_CmdRaise	Link
	RunRevAuto	YC-P3020_CmdLower	Link
	RestartDly	0 sec	Const
Outputs Destinations	Parameter	Destination	Type
	CmdStartFwd	CM-P304.CmdRaise	I/O
	CmdStartRev	CM-P304.CmdLower	I/O
Alarms	Priority as per class		
Additional Logic	Set Flt if CmdStartFwd is true for more than YC-P3020_HoistRaiseLowerDly consecutively. Set Flt if CmdStartRev is true for more than YC-P3020_HoistRaiseLowerDly consecutively.		

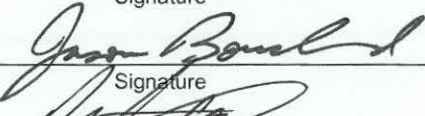
Note: Forward raises the hoist; Reverse lowers it.

	FUNCTIONAL REQUIREMENTS SPECIFICATION	Document Code: A-0102-AFRS-P004
		Revision: 0
Client: City of Winnipeg	Project: Primary Clarifiers Travelling Bridges Refurbishment	Package / Area: PLC-P311

Prepared By: DUSTIN WILSON		2018-08-28
Name	Signature	Date
Checked By: JASON BOUCHARD		2018-08-28
Name	Signature	Date
Approved By: DUSTIN WILSON		2018-08-28
Name	Signature	Date

<p>Certificate of Authorization</p> <div style="border: 1px solid black; padding: 10px; text-align: center;">  <p>ENGINEERS GEOSCIENTISTS MANITOBA</p> <p>Certificate of Authorization</p> <p>KGS Group</p> <p>No. 245</p> </div>	<p>Professional Seal</p> <div style="text-align: center;">  <p>2018-08-28</p> </div>
--	--

REVISION REGISTER					
Rev.	Description	Date	By	Checked	Approved
0	Issued for Use	2018-08-28	D. Wilson	J. Bouchard	D. Wilson

	FUNCTIONAL REQUIREMENTS SPECIFICATION	Document Code: A-0102-AFRS-P004
		Revision: 0
Client: City of Winnipeg	Project: Primary Clarifiers Travelling Bridges Refurbishment	Package / Area: PLC-P311

Table of Contents

1	Overview.....	3
1.1	Associated Documents	3
2	General Requirements.....	5
2.1	Human Machine Interface.....	5
2.1.1	Screen Layout.....	5
2.1.2	Graphic Displays.....	5
2.2	Inputs from Other PLCs	6
2.3	Logic and variables for other PLCs.....	6
3	Implementation	7
3.1	Simple Class Instances.....	7
3.1.1	DiscreteIA (Discrete Indication and / or Alarming).....	7
3.2	P4 – Travelling Bridges.....	8
3.2.1	Clarifier 3 Travelling Bridge Collector	8

	FUNCTIONAL REQUIREMENTS SPECIFICATION	Document Code: A-0102-AFRS-P004
		Revision: 0
Client: City of Winnipeg	Project: Primary Clarifiers Travelling Bridges Refurbishment	Package / Area: PLC-P311

1 OVERVIEW

The logic specified in this document is intended to provide functional requirements for PLC-P311 for the Primary Clarifier 3 Travelling Bridge. Refer to document A-0102-AFRS-A001 for general requirements and standard equipment classes. It is written from a technical perspective, and is intended to be read along with the associated Process & Instrument Diagram (P&ID) drawings.

This Functional Requirement Specification (FRS) document is intended to provide an initial basis for development of the PLC and HMI application functionality for the specific process area described herein. The Contractor must provide further development of the PLC and HMI functionality described in this document for a complete and functional system. It is written from a technical perspective and is intended to be read in parallel with the Process Control Narratives (PCNs), the associated Process and Instrument Diagrams (P&IDs), the Instrument Loop Drawings (ILDs) and the other PLC related contract documents. In the event of any discrepancy or any ambiguity, the PCNs, P&IDs, ILDs and other contract documents take precedence (in no specific order of importance) over the FRS documents. Any significant discrepancy should be clarified with the Contract Administrator. All discrepancy resolutions should be documented and submitted as part of the as-built markups. If there are discrepancies from a scope of work perspective, the more stringent requirement shall apply. All scope of work discrepancies should be clarified with the Contract Administrator.

Control functions are described using pseudo code and encapsulated in classes (some of which are commonly applicable for similar or identical equipment systems). These classes may therefore be instantiated as necessary to control similar types of equipment throughout the facility. Each class defines a control interface whose inputs and outputs are interconnected to implement the overall process control strategy as defined by the PCNs, P&IDs, ILDs, etc. and the FRS document. The specific area FRS documents are supported by the General FRS document which provides common definitions for software development required throughout the entire facility.

While the FRS documents provide specific guidance with respect to software development, they should not be presumed to be comprehensive of all software development requirements. Ultimately the P&IDs, the PCNs and the ILDs will govern and take precedence. It is the responsibility of the Contractor to utilize its expertise to provide a fully functional set of developed software in accordance with the contract documents even if not described within the FRS document at no additional cost to the contract. It is the specific responsibility of the Contractor to identify, seek clarification and ultimately resolve any issues of ambiguity, interpretation, uncertainties or discrepancies between the FRS documents and the associated contract documents. This responsibility extends to the need for consultation, as necessary, with the process designers, process equipment vendors, the Engineer, the Owner and any other relevant stakeholders to resolve any issue in accordance with the Contractor's legal obligations for the delivery of the work.

1.1 Associated Documents

The documents and drawings associated with this functional requirements specification are listed below. Additional P&ID drawings may be referenced in this document.

Document / Drawing Number	Description
1-0102-AFRS-A001	FUNCTIONAL REQUIREMENTS SPECIFICATION
612620-0014-40ER-0001	TAG NAMING STANDARD
612620-0015-40ER-0001	HMI LAYOUT AND AUTOMATION PLAN
1-0102-PPID-P401	PROCESS AND INSTRUMENTATION DIAGRAM – CLARIFIER 1 TRAVELLING BRIDGE COLLECTOR

	FUNCTIONAL REQUIREMENTS SPECIFICATION	Document Code: A-0102-AFRS-P004
		Revision: 0
Client: City of Winnipeg	Project: Primary Clarifiers Travelling Bridges Refurbishment	Package / Area: PLC-P311

Document / Drawing Number	Description
1-0102-AILD-P308 SHT. 001	LOOP DIAGRAM – RIO-P311 INPUTS / RIO-P800-2 OUTPUTS
1-0102-AILD-P308 SHT. 002	LOOP DIAGRAM – RIO-P311 INPUTS / RIO-P800-2 OUTPUTS
1-0102-AILD-P309 SHT. 001	LOOP DIAGRAM – RIO-P311 OUTPUTS / RIO-P800-2 INPUTS
1-0102-AILD-P309 SHT. 002	LOOP DIAGRAM – RIO-P311 OUTPUTS / RIO-P800-2 INPUTS
1-0102-ACBD-P309 SHT. 001	CABINET LAYOUT - PRIMARY CLARIFIERS - LCP-P311, TRAVELLING BRIDGE PLC CABINET - PLC-P311-1
1-0102-ACBD-P310 SHT. 001	POWER DISTRIBUTION SCHEMATIC - PRIMARY CLARIFIERS - LCP-P311-1, TRAVELLING BRIDGE PLC CABINET - PLC-301
1-0102-ACBD-P310 SHT. 002	POWER DISTRIBUTION SCHEMATIC - PRIMARY CLARIFIERS - LCP-P311-1, TRAVELLING BRIDGE PLC CABINET - PLC-301 - SHEET 002
1-0102-ACBD-P311 SHT. 001	WIRING DIAGRAM - PRIMARY CLARIFIERS - LCP-P311, LCP-P311-1, PLC-P311 - DISCRETE INPUTS
1-0102-ACBD-P312 SHT. 001	WIRING DIAGRAM - PRIMARY CLARIFIERS - LCP-P311, LCP-P311-1, PLC-P311 - DISCRETE OUTPUTS
1-0102-ACBD-P321 SHT. 001	CABINET LAYOUT - PRIMARY CLARIFIERS - LCP-P311-2, TRAVELLING BRIDGE PLC CABINET - RIO-P311
1-0102-ACBD-P322 SHT. 001	POWER DISTRIBUTION SCHEMATIC - PRIMARY CLARIFIERS - LCP-P311-2, TRAVELLING BRIDGE PLC CABINET - RIO-P311
1-0102-ACBD-P322 SHT. 002	POWER DISTRIBUTION SCHEMATIC - PRIMARY CLARIFIERS - LCP-P311-2, TRAVELLING BRIDGE PLC CABINET - RIO-301 - SHEET 002
1-0102-ACBD-P323 SHT. 001	WIRING DIAGRAM - PRIMARY CLARIFIERS - LCP-P311-2, RIO-P311 - DISCRETE INPUTS
1-0102-ACBD-P324 SHT. 001	WIRING DIAGRAM - PRIMARY CLARIFIERS - LCP-P311-1, PLC-P311 - DISCRETE OUTPUTS
1-0102-EGAD-P004 SHT. 001	POWER AND INSTRUMENTATION - MAIN FLOOR PLAN - PRIMARY CLARIFIER 3 ELEV 234.39M
1-0102-EMCL-P311 SHT. 001	MOTOR STARTER SCHEMATIC - TBC-P311 - PRIMARY CLARIFIER 3 TRAVELLING BRIDGE COLLECTOR
1-0102-EMCL-P311 SHT. 002	MOTOR STARTER SCHEMATIC - TBC-P311 - PRIMARY CLARIFIER 3 TRAVELLING BRIDGE COLLECTOR - SHEET 002
1-0102-EMCL-P313 SHT. 001	MOTOR STARTER SCHEMATIC - CM-P313 - PRIMARY CLARIFIER 3 COLLECTOR MECHANISM
1-0102-EMCL-P313 SHT. 002	MOTOR STARTER SCHEMATIC - CM-P313 - PRIMARY CLARIFIER 3 COLLECTOR MECHANISM
1-0102-ANET-P003 SHT. 007	NETWORK DIAGRAM - PRIMARY CLARIFIERS - DEVICE NETWORK
1-0102-ANET-P003 SHT. 008	NETWORK DIAGRAM - PRIMARY CLARIFIERS - DEVICE NETWORK

	FUNCTIONAL REQUIREMENTS SPECIFICATION	Document Code: A-0102-AFRS-P004
		Revision: 0
Client: City of Winnipeg	Project: Primary Clarifiers Travelling Bridges Refurbishment	Package / Area: PLC-P311

2 GENERAL REQUIREMENTS

Refer to document A-0102-AFRS-A001 for general requirements and standard classes.

2.1 Human Machine Interface

2.1.1 Screen Layout

The typical screen layout for the HMI graphic terminal shall be as shown in Figure 1. Navigation buttons shall reside across the bottom, a single-line alarm banner across the top, and the remainder of the screen allocated for the graphic display area. The graphic display area will be utilized for mimic displays, configuration screens, trends, and an alarm summary.

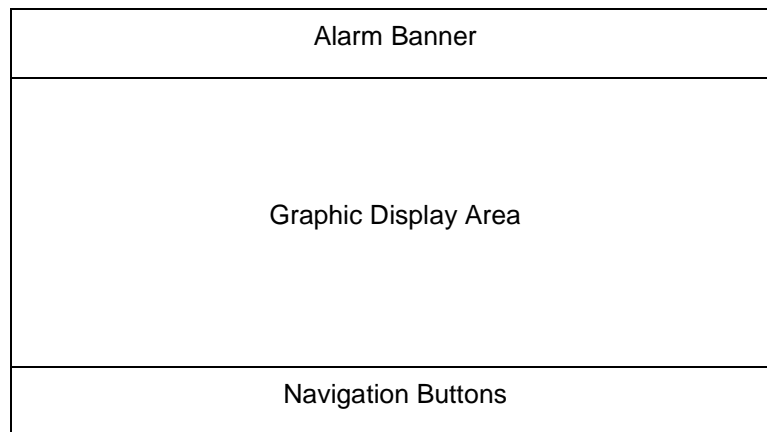

Figure 1: Screen Layout

2.1.2 Graphic Displays

Create Area Overview, Process Graphic and Detail displays as per City of Winnipeg HMI Layout and Animation plan document (612620-0015-40ER-0001) and General Functional Requirements Specification A-0102-AFRS-A001.

The following tables provide guidance on the minimum anticipated groupings of process displays, however, these should not be considered as fully defined, and modifications and additions may be required.

Note that only major or representative equipment and devices are explicitly shown in the graphic display tables. Include other devices as required for a complete HMI.

Refer to General Functional Requirements Specification A-0102-AFRS-A001 for Level 1 graphics.

Table 2.1-1 Level 2 Area P Graphic Displays – Primary Clarifier Overview

Group	Content
<ul style="list-style-type: none"> • Primary Clarifier 	TBC-P311 Clarifier 3 Travelling Bridge Collector Status <ul style="list-style-type: none"> - Bridge Sequence Status - Travelling Bridge Drive TBC-P311 Status - Sludge / Scum Scraper Hoist CM-P313 Status

	FUNCTIONAL REQUIREMENTS SPECIFICATION	Document Code: A-0102-AFRS-P004
		Revision: 0
Client: City of Winnipeg	Project: Primary Clarifiers Travelling Bridges Refurbishment	Package / Area: PLC-P311

Table 2.1-2 L3 and L4 Graphic Displays

Display Group	Level	Content
PCS Status	4	PLC Status and Basic Diagnostics for <ul style="list-style-type: none"> • Main Controller Rack • Remote I/O Rack • Networking Components (Including switch diagnostic when available) • Power Supplies
Overview Trends	4	(See Trends section below)

2.2 Inputs from Other PLCs

Some variables will be shared among different areas of the plant. They will be communicated via the Fibre Ethernet redundant ring connecting the PLCs. Variables that are read from other PLCs are listed below, along with their default value in the event of a communication failure.

The following table provides guidance on the minimum anticipated variables that are read from other PLC along with their default value in the event of a communication failure, however, these should not be considered as fully defined and modifications and additions may be required.

Input	Description	Source PLC	Value On Communication Error
T.B.D.	T.B.D.	T.B.D.	T.B.D.

2.3 Logic and Variables for Other PLCs

The following sections provide guidance on the minimum anticipated variables and logic required from this PLC for other PLCs, however, these should not be considered as fully defined and modifications and additions may be required.

Variable	Description	Source
PLC-P311_DiscreteInputTable	Pre-defined table for all discrete inputs	PLC-P311
PLC-P311_DiscreteOutputTable	Pre-defined table for all discrete outputs	PLC-P311
PLC-P311_AnalogInputTable	Pre-defined table for all analog inputs	PLC-P311
PLC-P311_AnalogOutputTable	Pre-defined table for all analog outputs	PLC-P311
PLC-P311_DiscreteStatusTable	Table to store discrete status information to be monitored remotely	PLC-P311
PLC-P311_IntegerTable	Table to store integer information to be monitored remotely	PLC-P311
PLC-P311_FloatingPointTable	Table to store floating point information to be monitored remotely	PLC-P311

Note: All Pre-defined tables shall include share space for the addition of two additional I/O modules.

	FUNCTIONAL REQUIREMENTS SPECIFICATION	Document Code: A-0102-AFRS-P004
		Revision: 0
Client: City of Winnipeg	Project: Primary Clarifiers Travelling Bridges Refurbishment	Package / Area: PLC-P311

3 IMPLEMENTATION

3.1 Simple Class Instances

The following tables show simple class instance implementations, other instances are shown in the rest of the document. In general, equipment with identical functionality for different systems is not explicitly shown.

3.1.1 DiscretelA (Discrete Indication and / or Alarming)

Table 3.1-1 Simple DiscretelA Instances

Instance	Source	Description	Alarms (Priority)	Notes
ZL-P3111	ZS-P3111	Clarifier 1 Bridge Drive TBC-P311 at East Position	Err(2)	P&ID: PPID-P401
ZL-P3112	ZS-P3112	Clarifier 1 Bridge Drive TBC-P311 at West Position	Err(2)	P&ID: PPID-P401
ZL-P3113	ZS-P3113	Clarifier 1 Bridge Drive TBC-P311 at East Overtravel Position	Err(2)	P&ID: PPID-P401
ZL-P3114	ZS-P3114	Clarifier 1 Bridge Drive TBC-P311 at West Overtravel Position	Err(2)	P&ID: PPID-P401
ZLL-P3131	CM-P313-ZSL	Clarifier 1 Scraper Hoist CM-P313 Lowered	Err(2)	P&ID: PPID-P401
ZLH-P3132	CM-P313-ZSH	Clarifier 1 Scraper Hoist CM-P313 Raised	Err(2)	P&ID: PPID-P401

	FUNCTIONAL REQUIREMENTS SPECIFICATION	Document Code: A-0102-AFRS-P004
		Revision: 0
Client: City of Winnipeg	Project: Primary Clarifiers Travelling Bridges Refurbishment	Package / Area: PLC-P311

3.2 P4 – Travelling Bridges

3.2.1 Clarifier 3 Travelling Bridge Collector

P&ID Drawing: PPID-P403

3.2.1.1 Clarifier 3 Travelling Bridge Control

The bridge travels East and West across the clarifier. As it travels East, the hoist will be lowered to scrape sludge to the sludge hoppers, as well as to push scum toward the scum cross collector. As it travels West, the hoist will be raised.

The operator may select either Sequence A or Sequence B operation for the bridge when in remote auto. The bridge will start either sequence from the East end of the clarifier. In Sequence A, the bridge travels the full length of the clarifier, pauses, and then returns to the East end. Sequence B is a series of shorter trips described in the state diagram for Sequence B.

Inputs From the HMI

Setting	Description	Initial Value	Range
HoistRaiseLowerDly	Time to allow hoist to completely raise or lower	20 sec	0 - 100 sec
A_DwellTime	Bridge Dwell Time (West End)	300 sec	0 – 300 sec
A_WaitTime	Bridge Wait Time (East End)	1 min	0 - 30 min
B_1stPauseTime	Length of First Pause for Seq B	60 sec	30 – 600 sec
B_2ndPauseTime	Length of Second Pause for Seq B	300 sec	30 – 600 sec
B_3rdPauseTime	Length of Third Pause for Seq B	300 sec	30 – 600 sec
B_4thPauseTime	Length of Fourth Pause for Seq B	60 sec	30 – 600 sec
B_5thPauseTime	Length of Fifth Pause for Seq B	60 sec	30 – 600 sec
B_Step1Time	Length of First Bridge Travel in Seq B	10 min	0 - 30 min
B_Step3Time	Length of Third Bridge Travel in Seq B	0.3 min	0 - 30 min
SeqResume	Resume Sequence from Paused State		

Note: Perform range checking on all HMI settings inputs to ensure that they are valid.
Prefix all alarm identifiers with “YC-P3110_”

Outputs for Display on HMI

Output	Description
SeqRdy	All bridge components are in remote auto mode

	FUNCTIONAL REQUIREMENTS SPECIFICATION	Document Code: A-0102-AFRS-P004
		Revision: 0
Client: City of Winnipeg	Project: Primary Clarifiers Travelling Bridges Refurbishment	Package / Area: PLC-P311

SeqARunning	Sequence A is currently running
SeqBRunning	Sequence B is currently running
SeqPaused	Bridge trip cycle is currently paused
SeqA_DwellTimeDisp	Amount of Time that the Bridge has been waiting at the West End (DwellA_Timer)
SeqA_WaitTimeDisp	Amount of Time that the Bridge has been waiting at the East End (WaitA_Timer)
SeqB_PauseTimeDisp	Time elapsed in current Pause timer (1stPause_Timer, 2ndPause_Timer, 3rdPause_Timer, 4thPause_Timer, 5thPause_Timer)
SeqB_StepTimeDisp	Time elapsed in current Step timer (Step1_Timer or Step3_Timer)
SeqB_WaitTimeDisp	Amount of Time that the Bridge has been waiting at the East End (WaitB_Timer)
SeqB_StateDisp	Current state in Sequence B: 300 = "Wait B" 360 = "Pause 3" 310 = "Step 1" 370 = "Return 2" 320 = "Pause 1" 380 = "Pause 4" 330 = "Return 1" 390 = "Full Travel" 340 = "Pause 2" 400 = "Pause 5" 350 = "Step 3" 410 = "Return 3"

Note: Prefix all identifiers with "YC-P3110_"

Table 3.2-1 YC-P3110_ SeqA / Bridge Sequence A/B Selector

Instance	YC-P3110_ SeqA		
Class	OnOffSel		
Inputs	Parameter	Source	Type
	SelOffText	"Sequence B Selected"	Const
	SelOnText	"Sequence A Selected"	Const

	FUNCTIONAL REQUIREMENTS SPECIFICATION	Document Code: A-0102-AFRS-P004
		Revision: 0
Client: City of Winnipeg	Project: Primary Clarifiers Travelling Bridges Refurbishment	Package / Area: PLC-P311

Table 3.2-2 YC-P3110 Clarifier 3 Travelling Bridge Control Station

Instance	YC-P3110		
Class	DiscreteCS		
Inputs	Parameter	Source	Type
	CtrlRem	N/A	Link
	CtrlLoc	N/A	Link
	Flt	YC-P3110_SeqFail.Out	Link
	RdyIn	NOT YC-P3110_SeqStopCond	Link
	Run	YC-P3110_SeqRunning	Link
	RunAuto	YC-P3110_SeqRdy OR YC-P3110.Running	Link
	StartInh	YC-P3110_SeqStopCond	Link
Alarms	(2)		

Note: Alarm priority as per default class definition or as shown

Sequence Ready Logic

YC-P3110_SeqRdy := YC-P3110_BridgeDrive.Rdy AND YC-P3130_BridgeHoist.Rdy AND NOT(CM-P313.Maint)

Sequence Stop Conditions

Set YC-P3110_SeqStopCond and stop the travelling bridge sequence (by immediately going to State 5 in the sequence) if ANY of the following stop conditions are true:

- NOT YC-P3110_SeqRdy (Sequence not ready)
- YC- P3110_SeqFail.In (Sequence fault condition)
- NOT YC-P3110.CmdRun AND YC-P3110.Running

Sequence Fault Conditions

Set YC-P3110_SeqFail if ANY of the following conditions are true:

- Any step in the sequence is active for longer than Tmax seconds, where Tmax is the maximum time allowed for a given step (See Sequence for Sludge Transfer below)

Set YC-P3110_EastMoveFault if ANY of the following conditions are true:

- Loss of Hoist Lowered Limit Switch (ZL-P3131.Out) for Tdelay seconds, where Tdelay is a time delay of 1-5 seconds.

Set YC-P3110_WestMoveFault if ANY of the following conditions are true:

- Loss of Hoist Raised Limit Switch (ZL-P3132.Out) for Tdelay seconds, where Tdelay is a time delay of 1-5 seconds.

	FUNCTIONAL REQUIREMENTS SPECIFICATION	Document Code: A-0102-AFRS-P004
		Revision: 0
Client: City of Winnipeg	Project: Primary Clarifiers Travelling Bridges Refurbishment	Package / Area: PLC-P311

3.2.1.2 YC-P3110_Sequence / Clarifier 3 Travelling Bridge Sequence

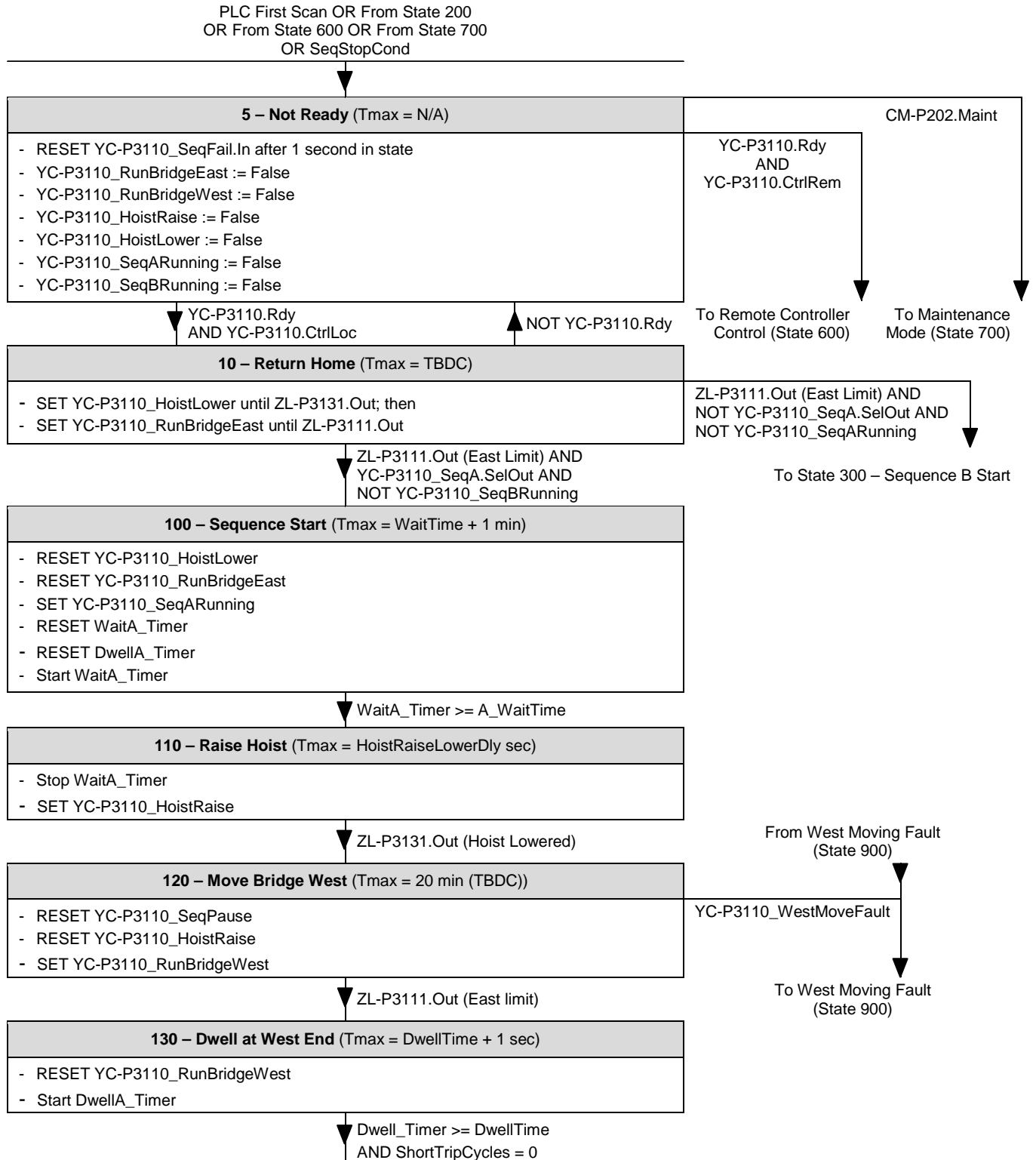

	FUNCTIONAL REQUIREMENTS SPECIFICATION	Document Code: A-0102-AFRS-P004
		Revision: 0
Client: City of Winnipeg	Project: Primary Clarifiers Travelling Bridges Refurbishment	Package / Area: PLC-P311

To Following Page

From Previous Page

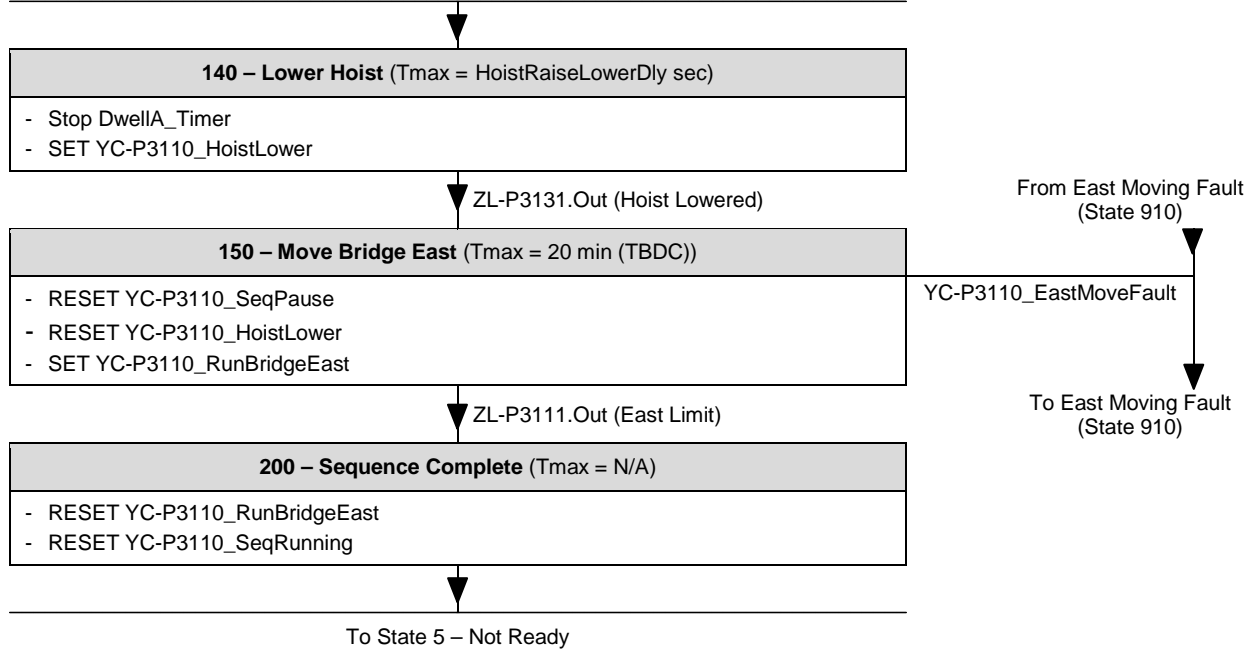

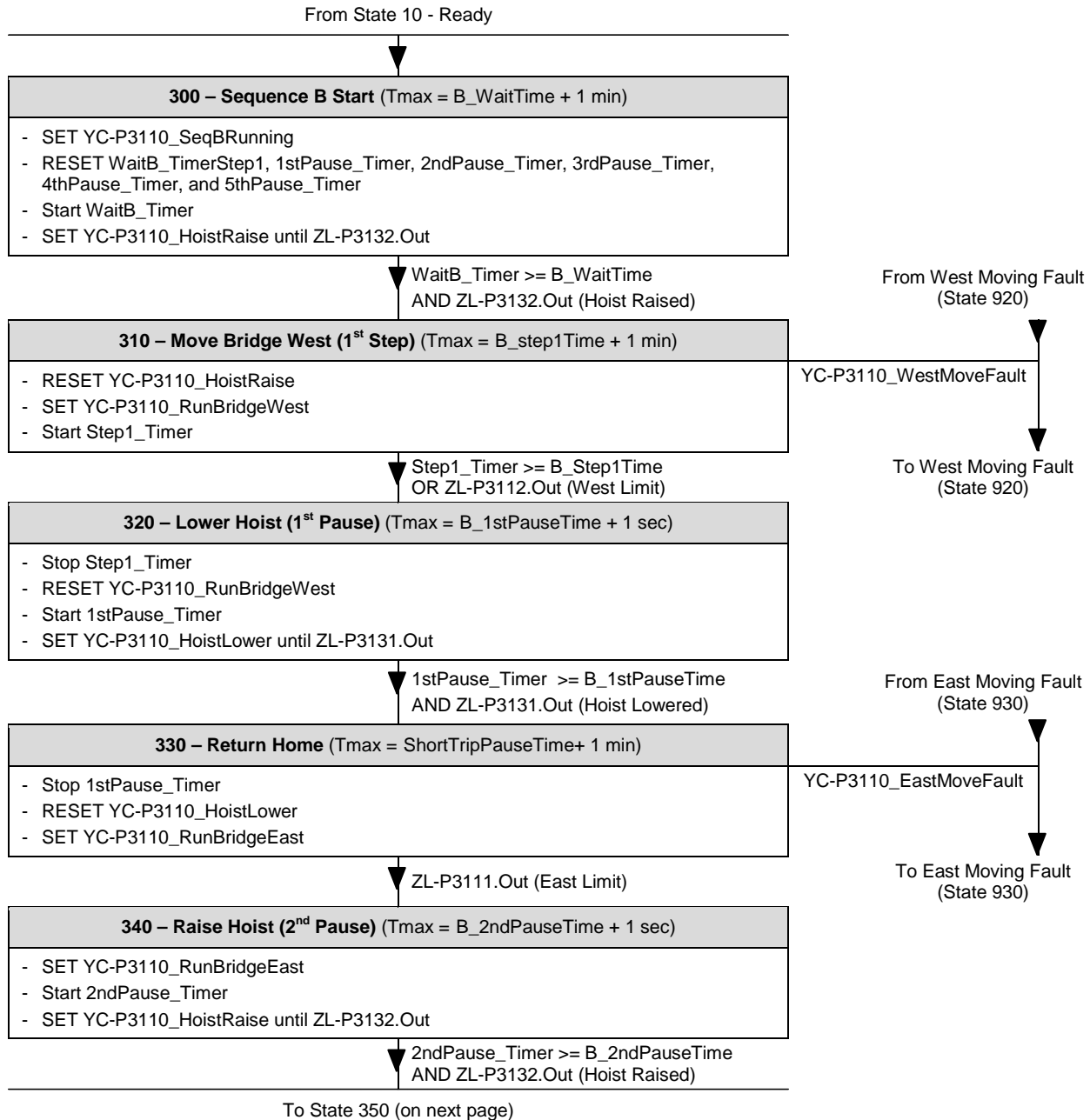

	FUNCTIONAL REQUIREMENTS SPECIFICATION	Document Code: A-0102-AFRS-P004
		Revision: 0
Client: City of Winnipeg	Project: Primary Clarifiers Travelling Bridges Refurbishment	Package / Area: PLC-P311

3.2.1.3 YC-P3110_Sequence / Clarifier 3 Travelling Bridge Sequence B

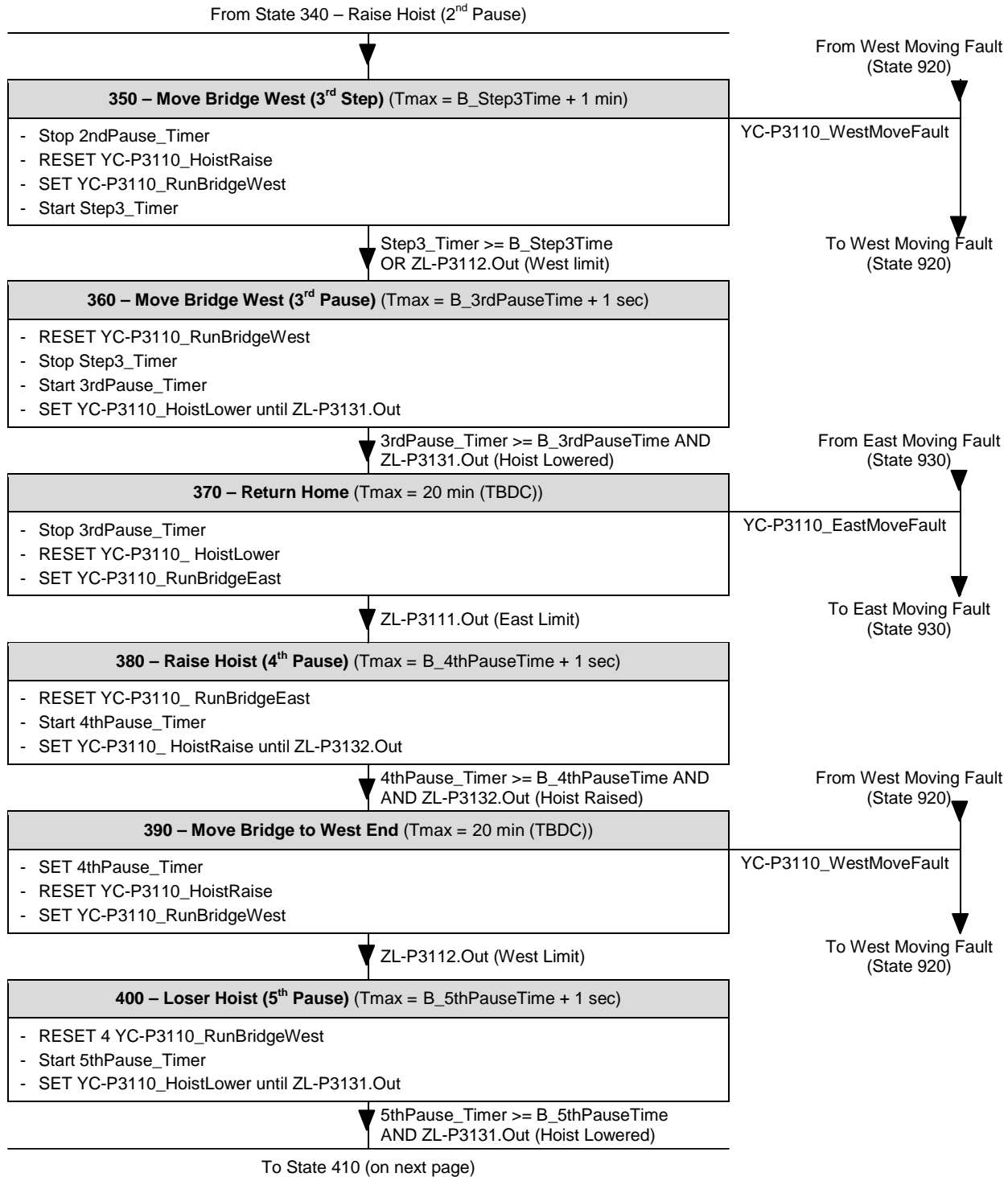

	FUNCTIONAL REQUIREMENTS SPECIFICATION	Document Code: A-0102-AFRS-P004
		Revision: 0
Client: City of Winnipeg	Project: Primary Clarifiers Travelling Bridges Refurbishment	Package / Area: PLC-P311



	FUNCTIONAL REQUIREMENTS SPECIFICATION	Document Code: A-0102-AFRS-P004
		Revision: 0
Client: City of Winnipeg	Project: Primary Clarifiers Travelling Bridges Refurbishment	Package / Area: PLC-P311

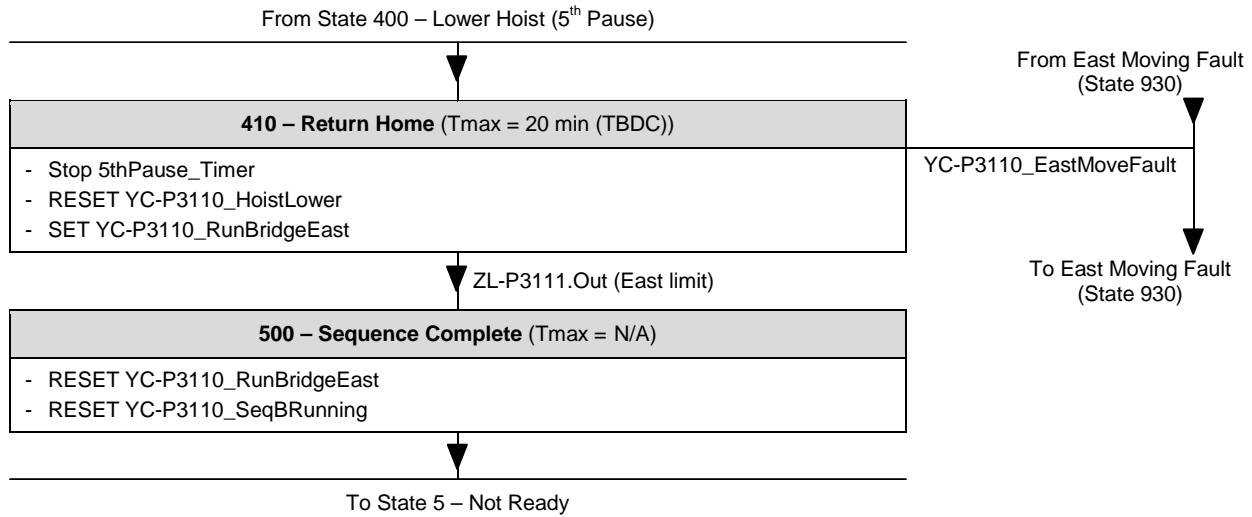

3.2.1.4 Remote Controller Control

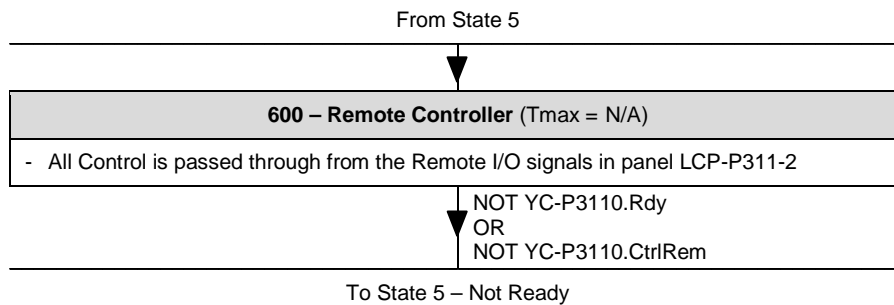

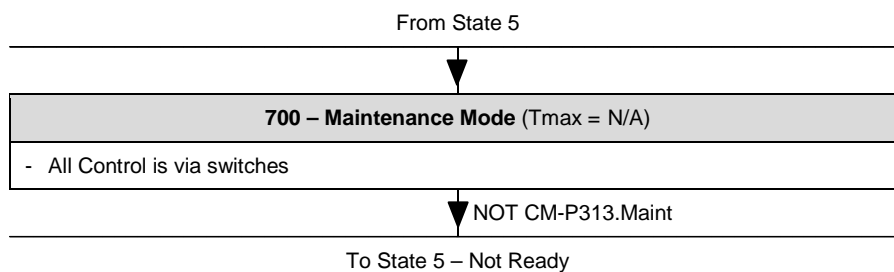

3.2.1.5 Maintenance Mode

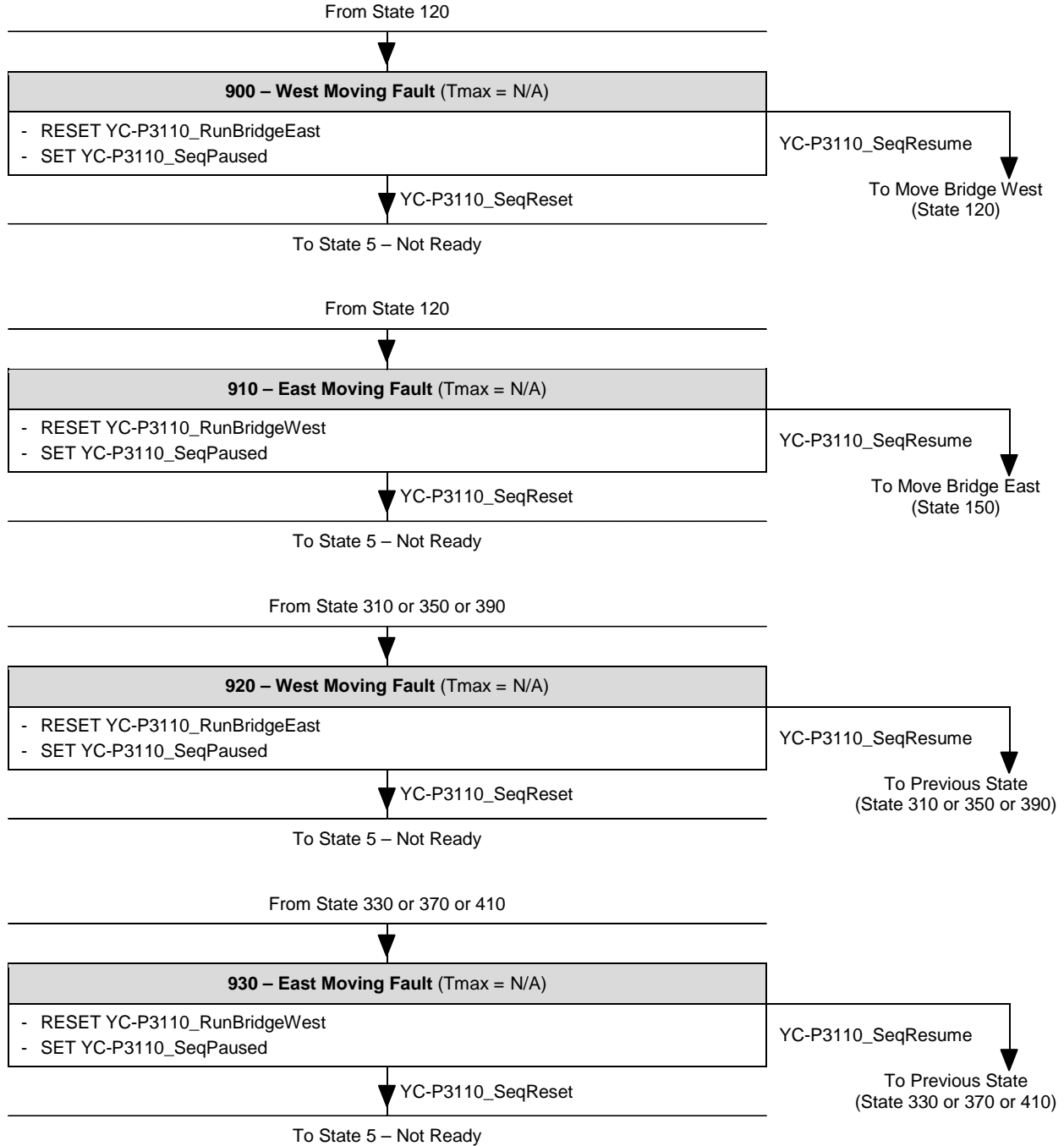

	FUNCTIONAL REQUIREMENTS SPECIFICATION	Document Code: A-0102-AFRS-P004
		Revision: 0
Client: City of Winnipeg	Project: Primary Clarifiers Travelling Bridges Refurbishment	Package / Area: PLC-P311

3.2.1.6 Alarm Lockouts



	FUNCTIONAL REQUIREMENTS SPECIFICATION	Document Code: A-0102-AFRS-P004
		Revision: 0
Client: City of Winnipeg	Project: Primary Clarifiers Travelling Bridges Refurbishment	Package / Area: PLC-P311

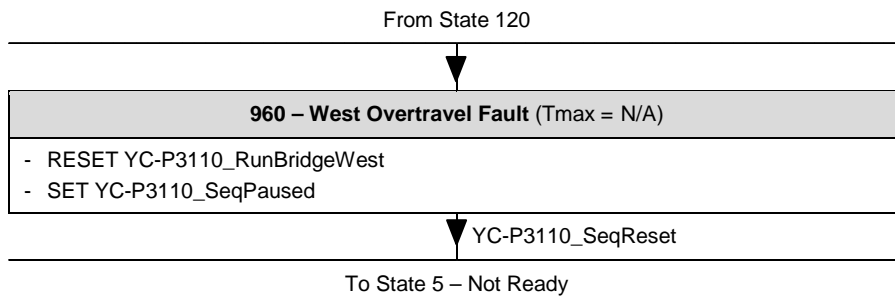
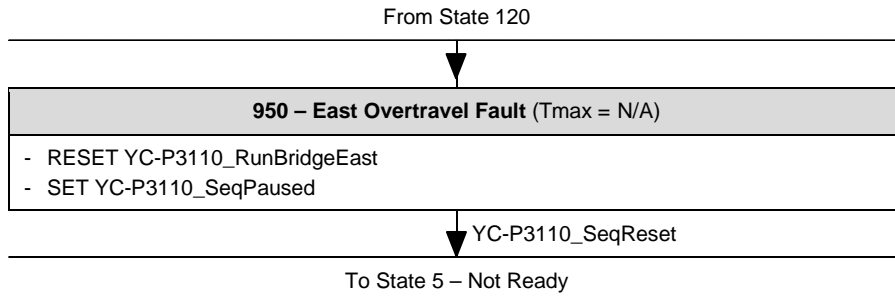

	FUNCTIONAL REQUIREMENTS SPECIFICATION	Document Code: A-0102-AFRS-P004
		Revision: 0
Client: City of Winnipeg	Project: Primary Clarifiers Travelling Bridges Refurbishment	Package / Area: PLC-P311

Table 3.2-3 YC-P3110_SeqFail / Clarifier 3 Travelling Bridge Sequence Fail

Instance	YC-P3110_SeqFail		
Class	DiscretelA		
Inputs	Parameter	Source	Type
	ExtRst	YC-P3110.RstDevAlms	Link
	In	See YC-P3110_Sequence Above	Link
Alarms	Alm(3) - Low Priority		

Table 3.2-4 YC-P3110_BridgeDrive / TBC-P311 Clarifier 3 Travelling Bridge Drive

Instance	YC-P3110_BridgeDrive		
Class	DiscreteCS_FwdRev		
Inputs	Parameter	Source	Type
	RunFbkDly	15 000 ms	Const
	CtrlRem	TBC-P311.Rem	I/O
	Flt	TBC-P311.Flt ¹	I/O
	PathNotRunRdyInFwd	ZL-P3111.Out	Link
	PathNotRunRdyInRev	ZL-P3112.Out	Link
	RunReqNoPathDly	1 sec	Const
	RunFwd	TBC-P311.RunEast	I/O
	RunRev	TBC-P311.RunWest	I/O
	RunFwdAuto	YC-P3110_CmdRunEast	Link
	RunRevAuto	YC-P3110_CmdRunWest	Link
	RestartDly	0 sec	Const
Outputs Destinations	Parameter	Destination	Type
	CmdStartFwd	TBC-P311.CmdRunEast	I/O
	CmdStartRev	TBC-P311.CmdRunWest	I/O
Alarms	Priority as per class		

Note: Forward moves bridge in the East towards the home position; Reverse moves it in the West direction

¹ Motor overload, or bridge has travelled past east or west limit

	FUNCTIONAL REQUIREMENTS SPECIFICATION	Document Code: A-0102-AFRS-P004
		Revision: 0
Client: City of Winnipeg	Project: Primary Clarifiers Travelling Bridges Refurbishment	Package / Area: PLC-P311

Table 3.2-5 YC-P3130_BridgeHoist / CM-P313 Clarifier 3 Travelling Bridge Hoist

Instance	YC-P3130_BridgeHoist		
Class	DiscreteCS_FwdRev		
Inputs	Parameter	Source	Type
	RunFbkDly	20 000 ms	Const
	CtrlRem	CM-P313.Rem	I/O
	Flt	(See additional logic)	Link
	PathNotRunRdyInFwd	ZL-P3132.Out	Link
	PathNotRunRdyInRev	ZL-P3131.Out	Link
	RunReqNoPathDly	1 Sec	Const
	RunFwd	CM-P313.RunRaise	I/O
	RunRev	CM-P313.RunLower	I/O
	RunFwdAuto	YC-P3110_CmdRaise	Link
	RunRevAuto	YC-P3110_CmdLower	Link
	RestartDly	0 sec	Const
Outputs Destinations	Parameter	Destination	Type
	CmdStartFwd	CM-P313.CmdRaise	I/O
	CmdStartRev	CM-P313.CmdLower	I/O
Alarms	Priority as per class		
Additional Logic	Set Flt if CmdStartFwd is true for more than YC-P3110_HoistRaiseLowerDly consecutively. Set Flt if CmdStartRev is true for more than YC-P3110_HoistRaiseLowerDly consecutively.		

Note: Forward raises the hoist; Reverse lowers it.